

SERVICE MANUAL

AM/FM STEREO TUNER AMPLIFIER

SANSUI 5000

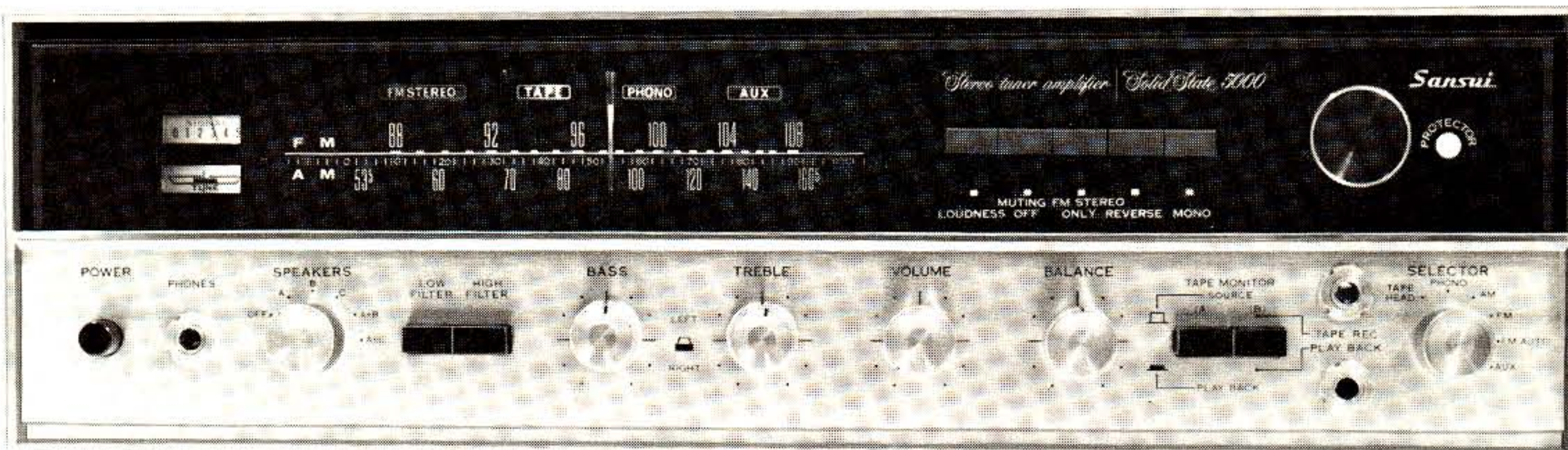

Sansui[®]

SANSUI ELECTRIC COMPANY LIMITED

CONTENTS

GENERAL TROUBLESHOOTING CHART	3, 4
DISASSEMBLY PROCEDURE	5
MOUNTING TEMPLATE	6
PARTS LAYOUT	7
BLOCK DIAGRAM	8
ALIGNMENT	
TEST POINTS	9
FM ALIGNMENT PROCEDURE	10
FM MPX ALIGNMENT PROCEDURE	11
AM ALIGNMENT PROCEDURE.....	12
PRINTED CIRCUIT SHEETS AND	
PARTS LIST.....	13, 14, 15, 16, 17, 18, 19, 20, 21, 22, 23, 24
OTHER PARTS CHART AND PARTS LIST	25, 26

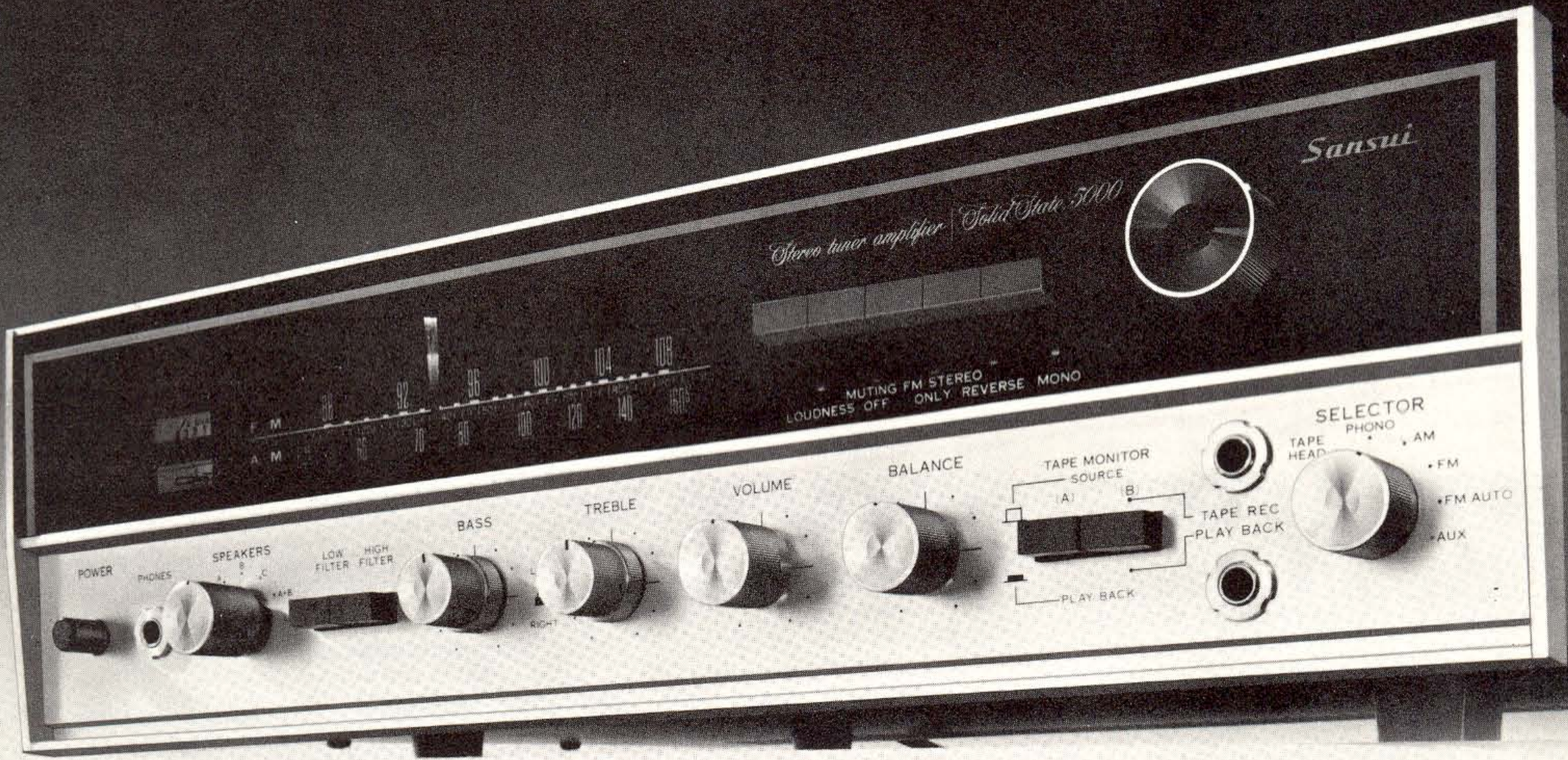

GENERAL TROUBLESHOOTING CHART

If the amplifier is otherwise operating satisfactorily, the more common causes of trouble may generally be attributed to the following:

1. Incorrect connections or loose terminal contacts. Check the speakers, record player, tape recorder, antenna and line cord.
2. Improper operation. Before operating any audio com-

- ponent, be sure to read the manufacturer's instructions.
3. Improper location of audio components. The proper positioning of components, such as speakers and turntable, is vital to stereo.
4. Defective audio components.

The following are some other common causes of malfunction and what to do about them.

PROGRAM	SYMPTOM	PROBABLE CAUSE	WHAT TO DO
AM, FM or MPX reception	A. Constant or intermittent noise heard at times or in a certain area	<ul style="list-style-type: none"> * Discharge or oscillation caused by electrical appliances, such as fluorescent lamp, TV set, D.C. motor rectifier or oscillator * Natural phenomena, such as atmospheric static or thunderbolts * Insufficient antenna input due to ferroconcrete wall or long distance from the station * Wave interference from other electrical appliances 	<ul style="list-style-type: none"> * Attach a noise limiter to the electrical appliance causing the noise, or attach it to the amplifier's power source * Install an outdoor antenna and ground the amplifier to raise the signal-to-noise ratio * Reverse the power cord plug-receptacle connections * If the noise occurs at a certain frequency, attach a wave trap to the ANT. input * Keep the set at a proper distance from other electrical appliances
	B. The needle of the signal and tune meter does not move sharply	<ul style="list-style-type: none"> * Receiver is located in a weak signal area 	<ul style="list-style-type: none"> * Place the set to receive maximum signal strength
	C. The zero point of the meter diverges much	<ul style="list-style-type: none"> * Regional difference in field intensity 	<ul style="list-style-type: none"> * The unit is not at fault
AM reception	A. Noise heard at a particular time of a day, in a certain area or over part of dial	<ul style="list-style-type: none"> * Due to the nature of AM broadcasts 	<ul style="list-style-type: none"> * Install the antenna for maximum antenna efficiency. See "ANTENNA" in the operating instructions * In some cases, the noise can be eliminated by grounding the amplifier or reversing the power cord plug-receptacle connections
	B. High-frequency noise	<ul style="list-style-type: none"> * Adjacent-channel interference or beat interference * TV set too close to audio system 	<ul style="list-style-type: none"> * Although such noise cannot be eliminated by the amplifier, it is advisable to adjust the TREBLE control from midpoint to left and switch on the HIGH FILTER * Keep the TV set at a proper distance from the audio system
FM reception	A. Noisy	<ul style="list-style-type: none"> * Poor noise limiter effect or too low S/N ratio due to insufficient antenna input 	<ul style="list-style-type: none"> * Install the antenna (attached) for maximum signal strength * If this does not prove effective, use an outdoor antenna designed exclusively for FM. When you use a TV antenna for both TV and FM with a divider, make sure TV reception is not affected * An excessively long antenna may cause noise
	<p>Note: FM reception is affected considerably by transmission conditions of stations: power and antenna efficiency. As a result, you may receive one station quite well while receiving another station poorly</p>		

PROGRAM	SYMPTOM	PROBABLE CAUSE	WHAT TO DO
FM reception (cont'd)	B. Noise heard like "Scratch noise" heard	* Ignition noise caused by starting of an automobile engine	* Install the antenna and its lead-in wire in proper distance from the road or raise the antenna input as described above
	C. Tuning noise between stations	* This results from the nature of the FM reception. As the station signal becomes weak, the noise limiter effect is decreased, and the amplification of the limiter, in turn, is enlarged, generating a noise	* Turn the MUTING switch on. It reduces the sensitivity, and therefore it should be used sparingly
FM-MPX reception	A. Noise heard during FM-MPX reception while not heard during FM mono reception	* Weaker signal because the service area of the FM-MPX broadcast is only half that of the FM mono broadcast	* Install the antenna for maximum antenna input * Switch on the high filter and/or turn the TREBLE control from midpoint, left
	B. Clearness of channel separation is decreased during reception	* Excess heat	* Circulation of air is important to the amplifier. Be sure that air is flowing under the amplifier
	C. The stereo indicator blinks on and off	* Interference	* The indicator is not at fault, adjust VR ₄₀₁
	D. The stereo indicator blinks on and off even though stereo station is not received	* Interference	* The indicator is not at fault, adjust VR ₄₀₁
Record playing or tape playback	A. Hum or howling	* Record player placed directly on speaker * Wire other than shielded wire used * Loose terminal contact * Shielded wire too close to line cord, fluorescent lamp or other electrical appliances * Nearby amateur radio station or TV transmission antenna	* Place a cushion between the player and the speaker box or place them away from each other * The connecting shielded wire should be as short as possible * Switch on the LOW FILTER and adjust the BASS control from midpoint, left * Consult the nearest Radio Regulatory Bureau
	B. Surface noise	* Worn or old record * Worn needle * Needle dusty * Improper needle pressure	* Recondition the playback head of the tape recorder or the needle the record player * Adjust the TREBLE control from midpoint, left * HIGH FILTER on
All stereo programs	BALANCE control is not at midpoint when equal sound comes from left and right channels	* It is important to adjust for equal sound from both channels. It should not always be set to the midpoint	* Set the MONO switch to MONO and then set the BALANCE control to a position where equal sound comes from both channels

DISASSEMBLY PROCEDURE

REMOVING THE FRONT PANEL, BONNET AND BOTTOM PLATE

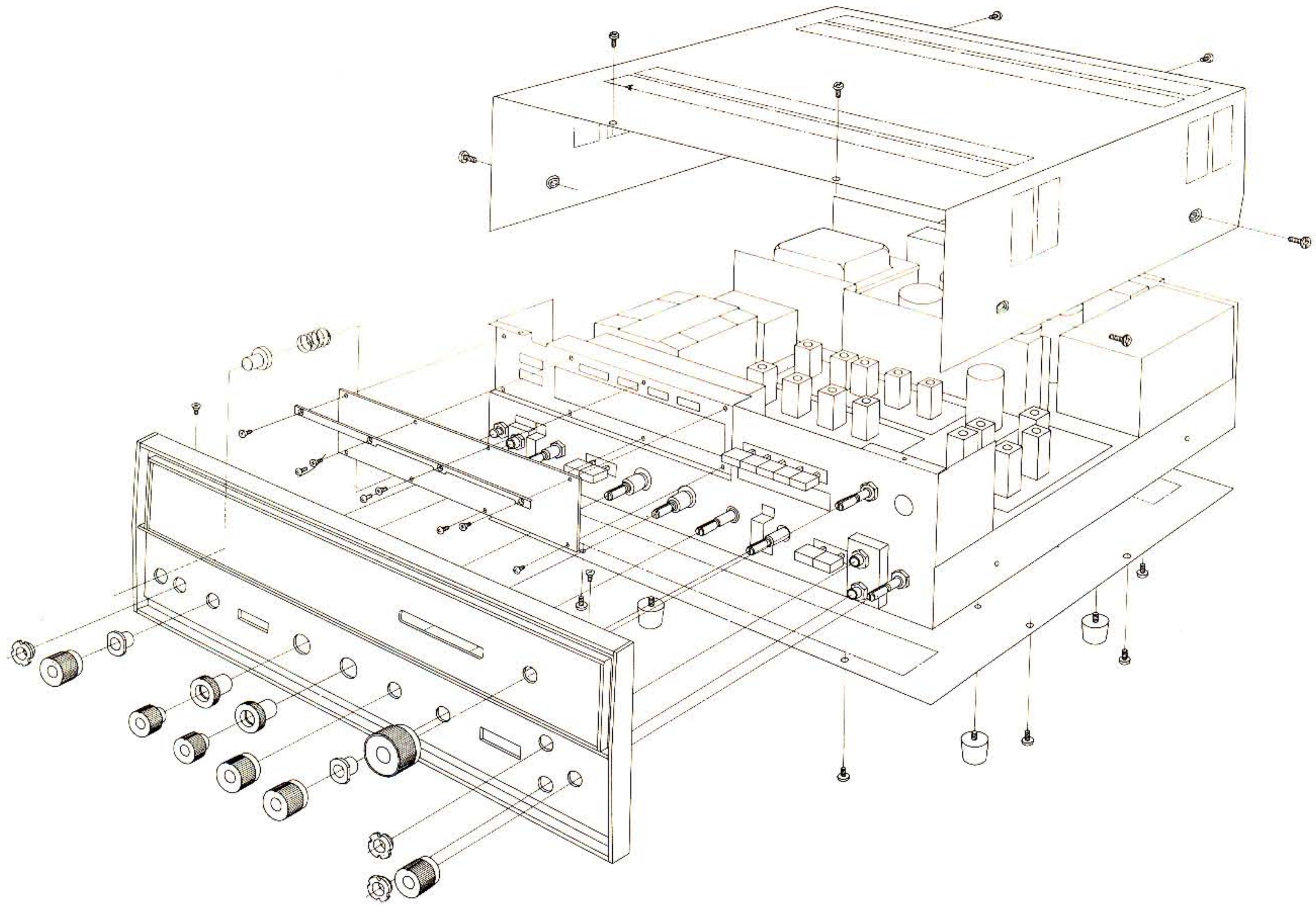

DIAL MECHANISM

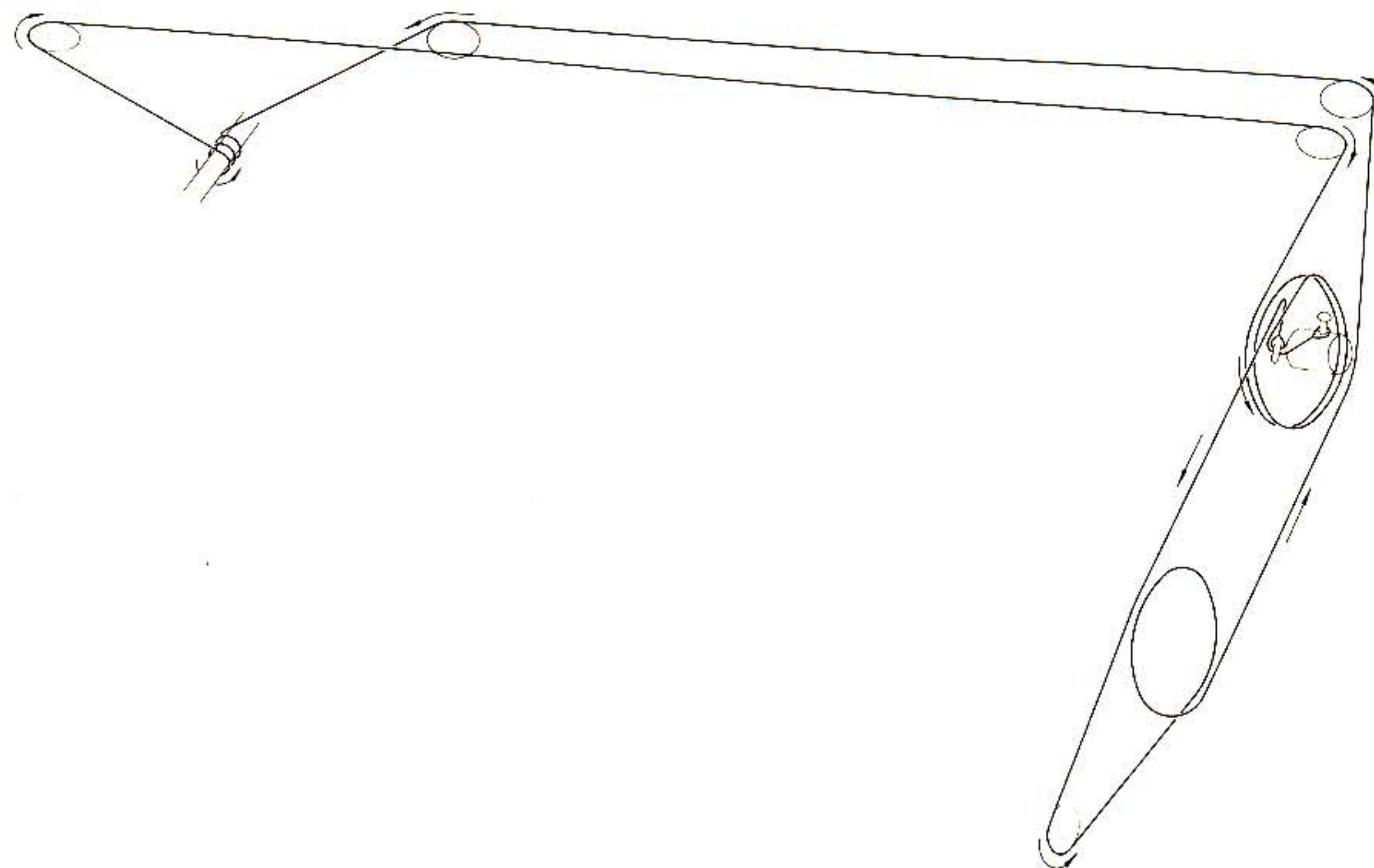

MOUNTING TEMPLATE

This diagram shows the size and dimensions required for mounting the 5000 into a custommade cabinet. Note that ample space is provided for complete air circulation above and below the tuner.

1. Be sure the cabinet window measures $17'' \times 4\frac{9}{16}''$ as indicated in the diagram.
2. Place two boards on the floor of the cabinet as illustrated. Boards should measure $\frac{25}{32}'' \times \frac{25}{32}'' \times 9\frac{1}{16}''$.

3. Drill two holes in the bottom of the cabinet at points corresponding to holes in the bottom of the tuner.

4. Remove the four rubber feet from the 5000. (Retain for future use.)

5. Insert the 5000 into the cabinet through the window until the edges of its front panel are flush with the cabinet, and secure both tuner and cabinet with washers and butterfly bolts provided.

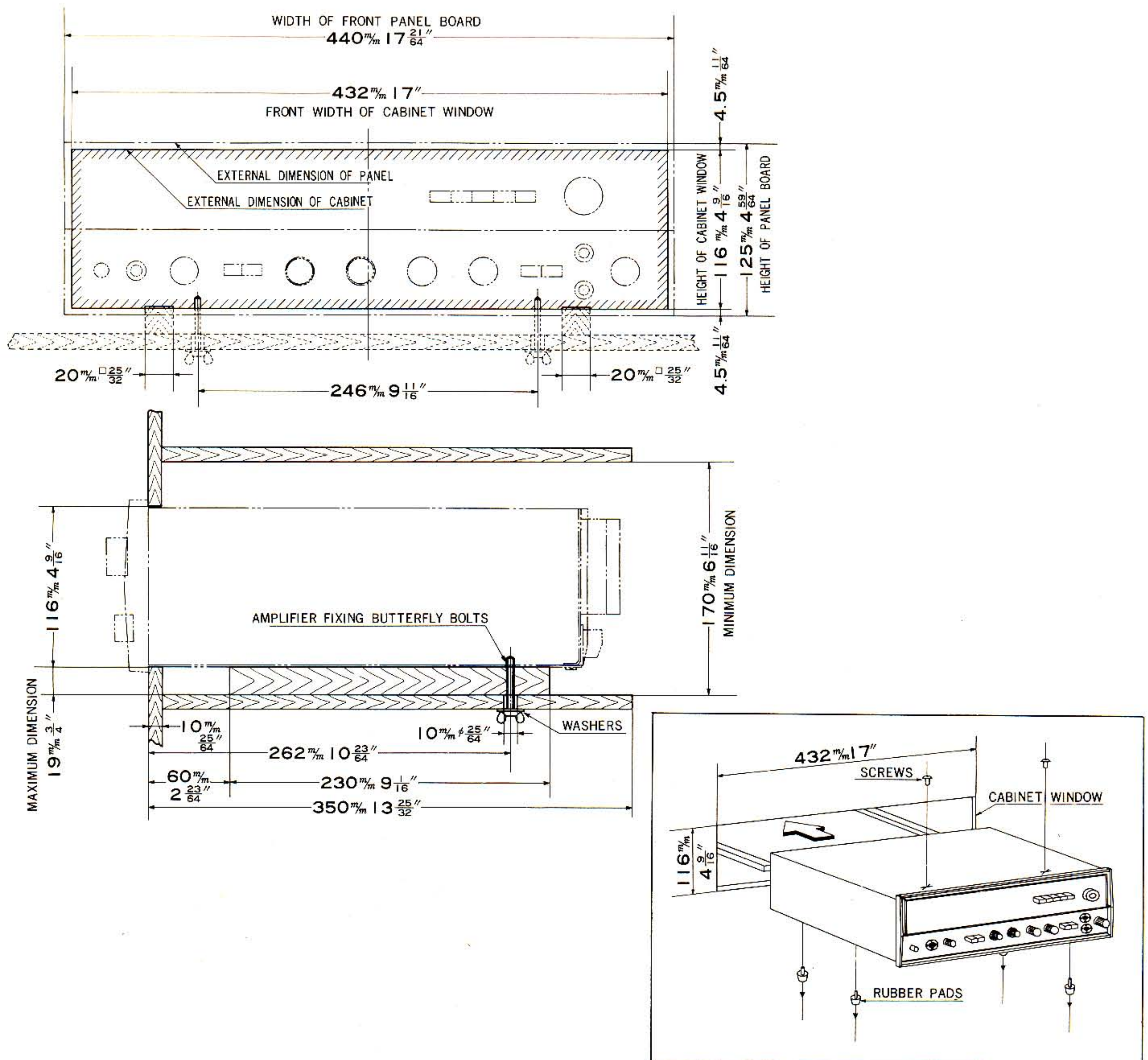

PARTS LAYOUT

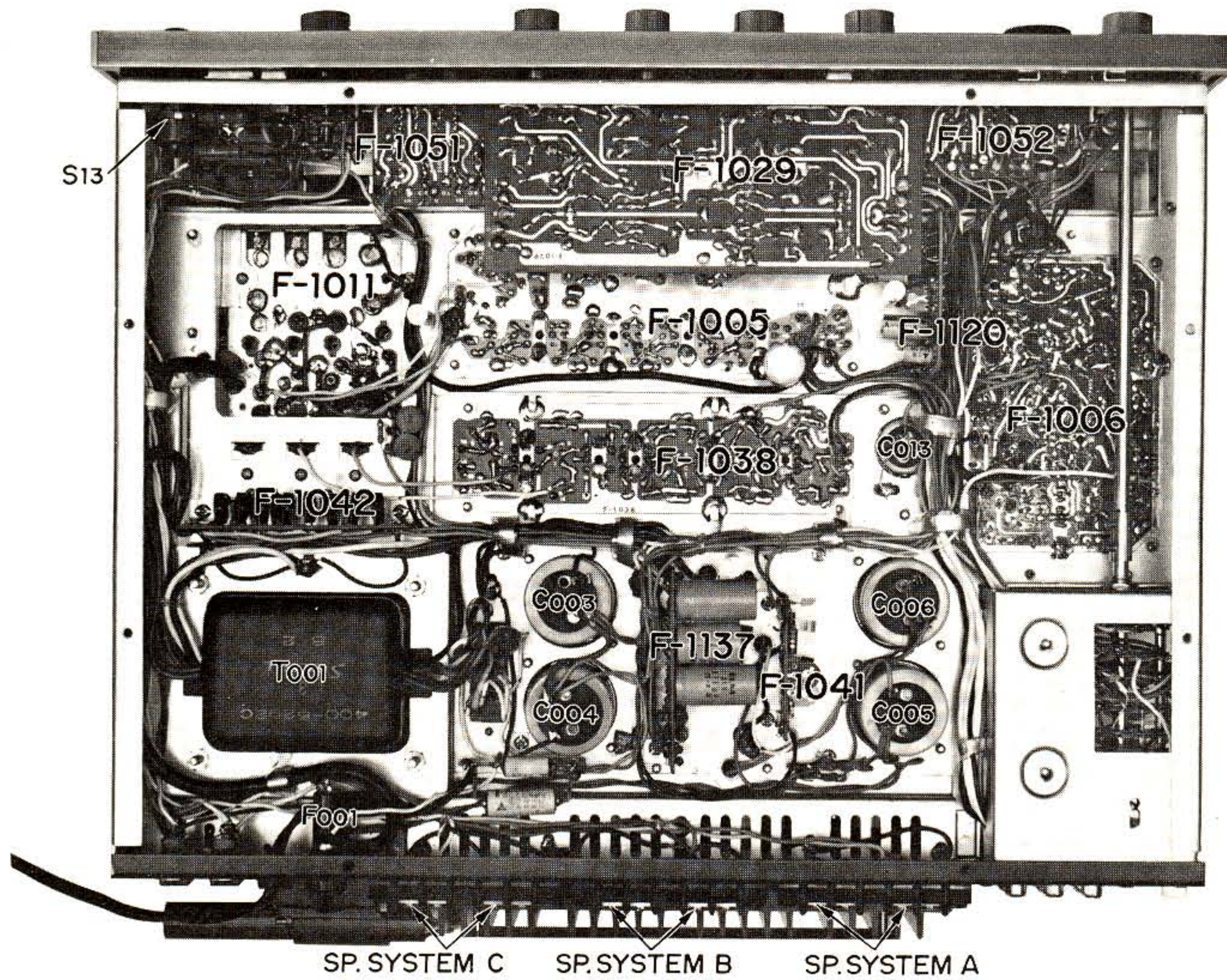
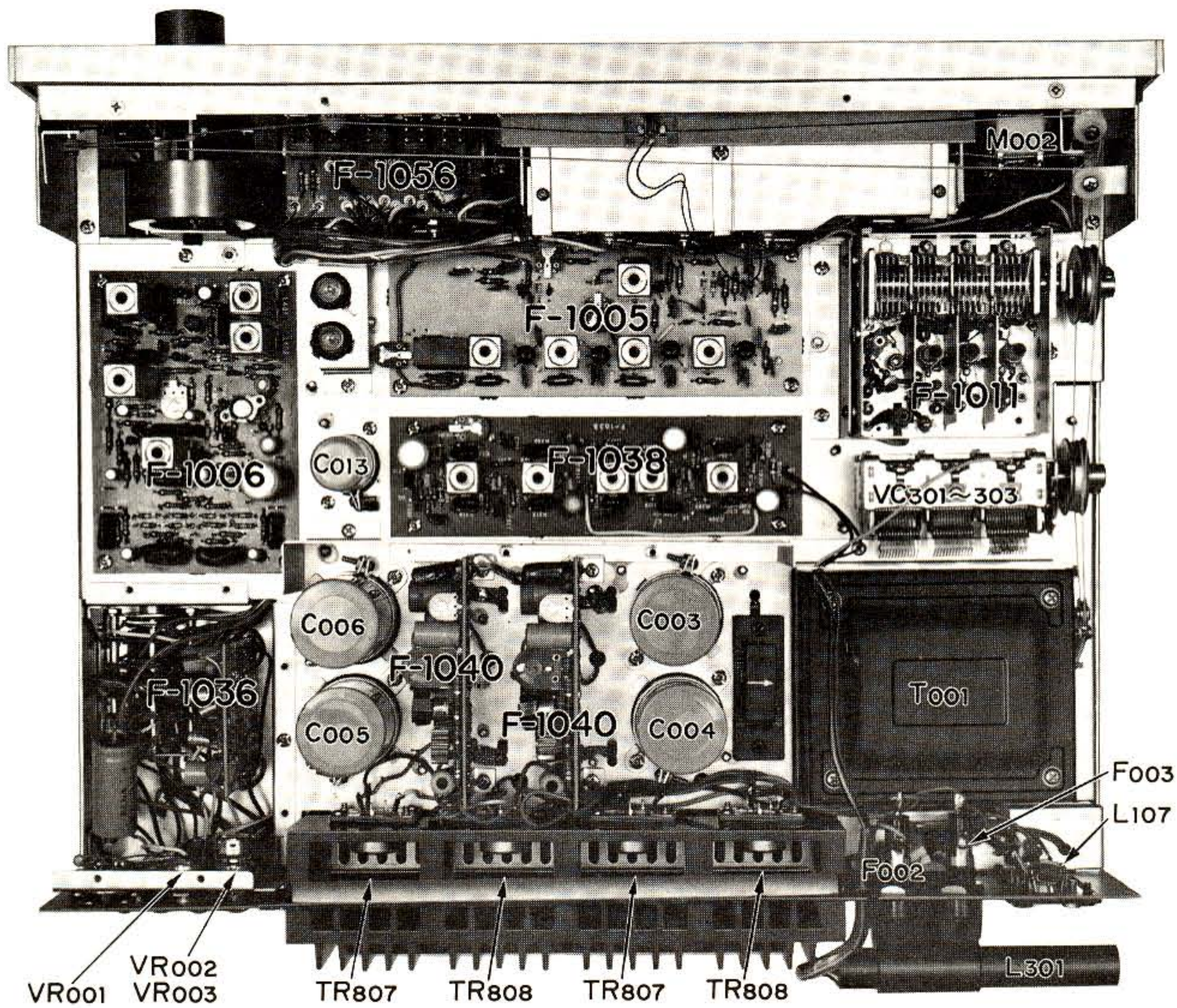

BLOCK DIAGRAM

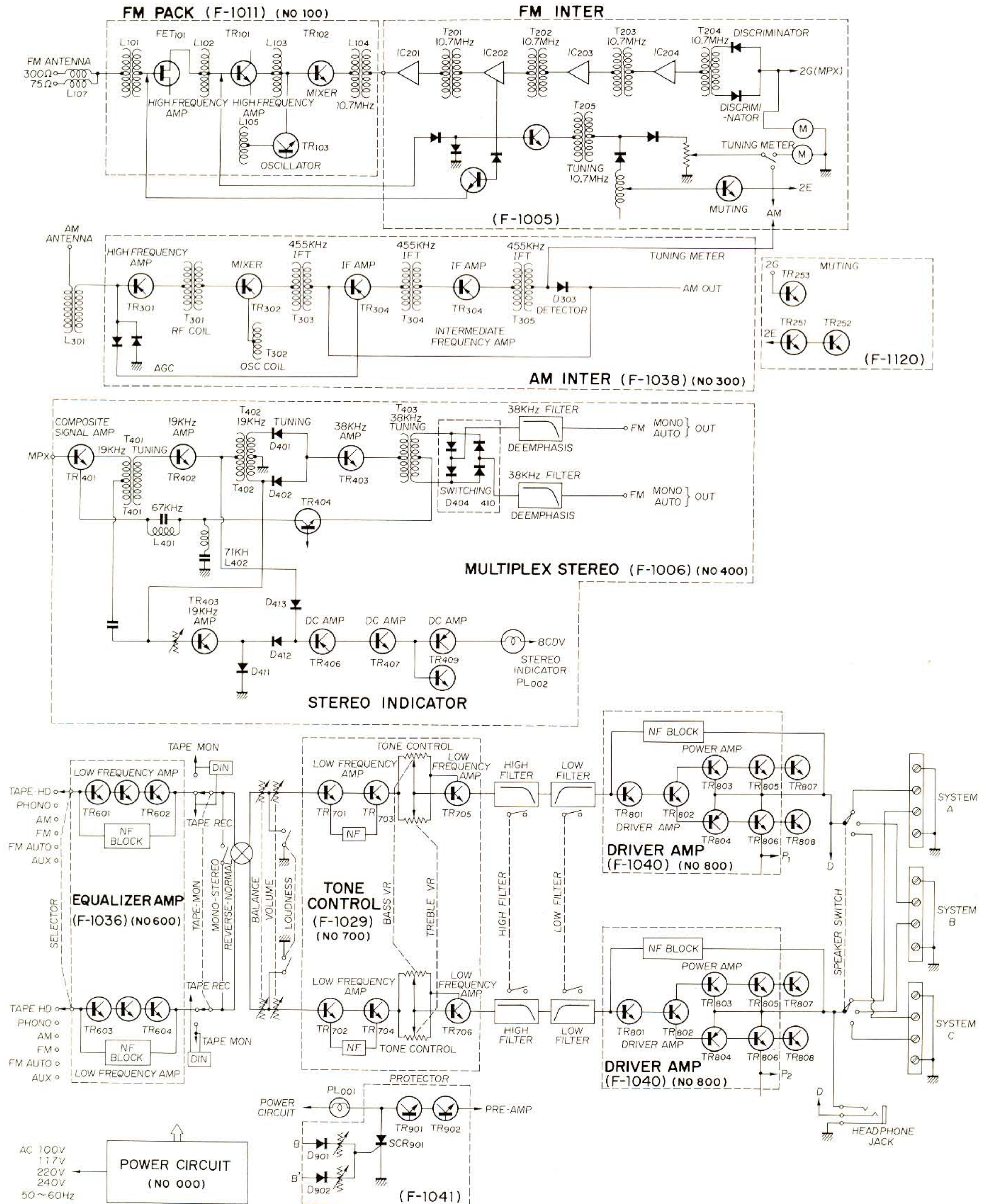

ALIGNMENT

TEST POINTS

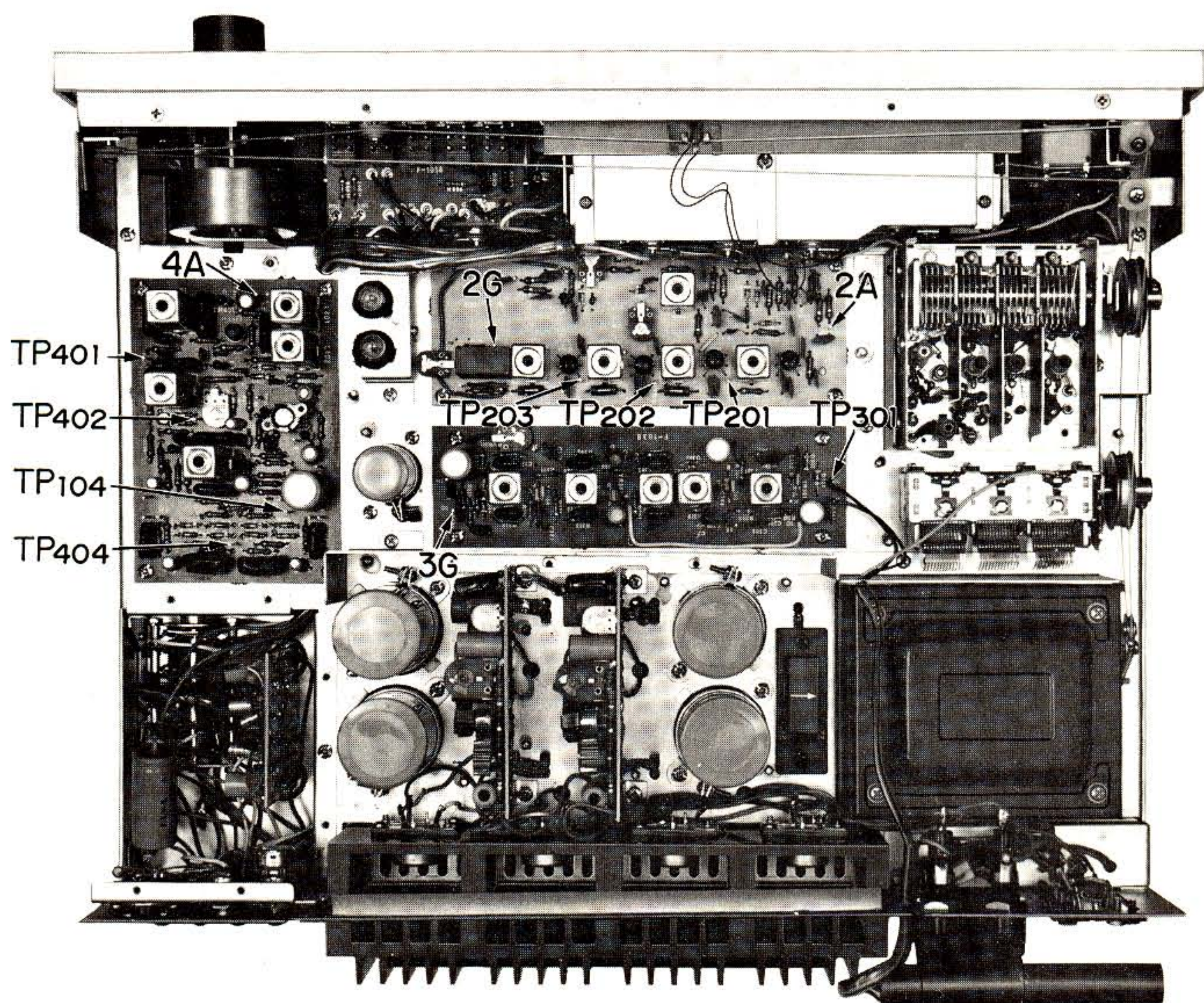
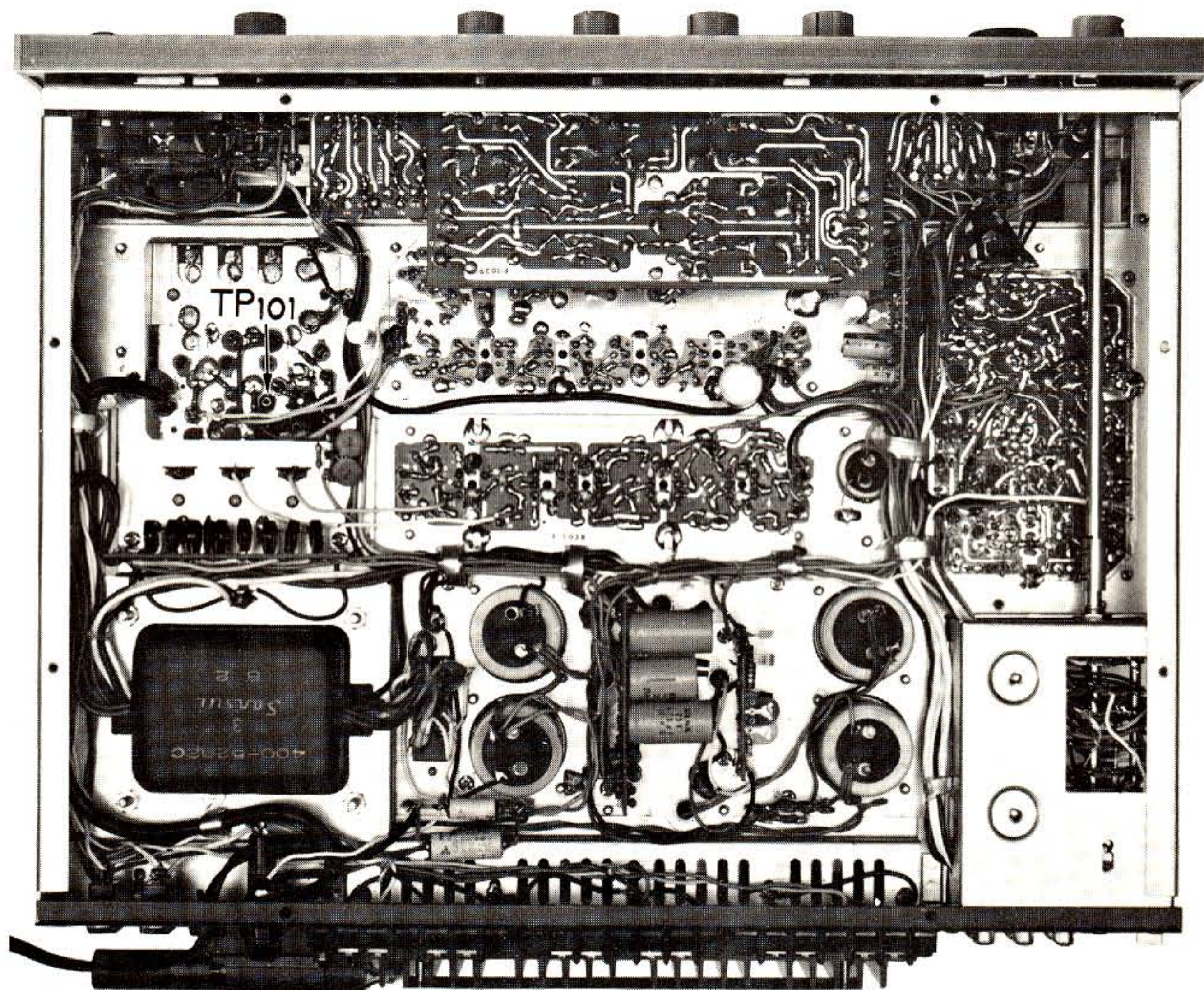

FM ALIGNMENT PROCEDURE

NOTE: To align, set the signal generator level to minimum.
 Turn tuning gang fully.
 Center carrier wave.
 Set pointer at reference mark.

STEP	ALIGN	GENERATOR	FEED SIGNAL	OUTPUT INDICATOR	DIAL SETTING	ADJUST	ADJUST FOR
1.	IF Transformer	10.7 MHz ±200 KHz	Sweep signal is sent to TP ₁₀₁ via the 10pF ceramic condenser	Oscilloscope is connected to TP _{201, 202} and TP ₂₀₃ via the 10pF ceramic condenser with probe		Top and bottom sides of T _{202, 203}	Best I.F.T. wave form
2.	Discriminator	10.7 MHz ±200 KHz	Sweep signal is sent to TP ₁₀₁ via the 10pF ceramic condenser	Oscilloscope is connected to 2G		FM. Discriminator is transformer T ₂₀₄ top and bottom sides	S curve
3.	O.S.C	90 MHz 400 Hz 100% Modulation	To antenna terminals	Oscilloscope and V.T.V.M. at output load	90 MHz	O.S.C. coil L ₁₀₅	Maximum
4.	O.S.C	106 MHz 400 Hz 100% Modulation	To antenna terminals	Oscilloscope and V.T.V.M. at output load	106 MHz	O.S.C. trimmer TC ₁₀₄	Maximum
5.	Reiterate 3 and 4.						
6.	High-frequency Amp. Circuit	90 MHz 400 Hz 100% Modulation	To antenna terminals	Oscilloscope and V.T.V.M. at output load	90 MHz	Antenna coil L _{101, L102} and L ₁₀₃	Maximum
7.	High-frequency Amp. Circuit	106 MHz 400 Hz 100% Modulation	To antenna terminals	Oscilloscope and V.T.V.M. at output load	106 MHz	Trimmer TC _{101, TC102} and TC ₁₀₃	Maximum
8.	Reiterate 6 and 7.						

FM IF WAVE FORM

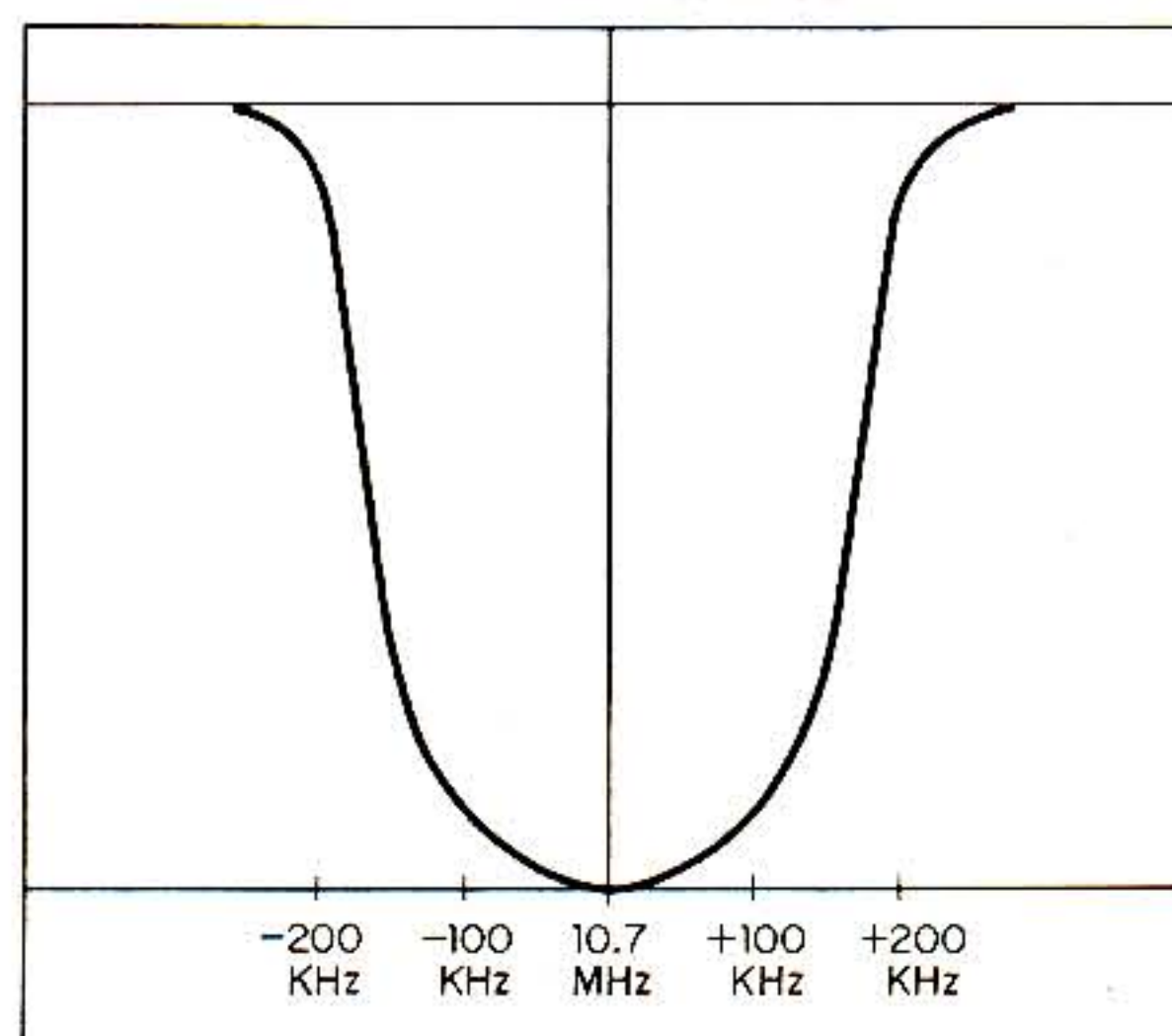

FM DISCRIMINATOR WAVE FORM

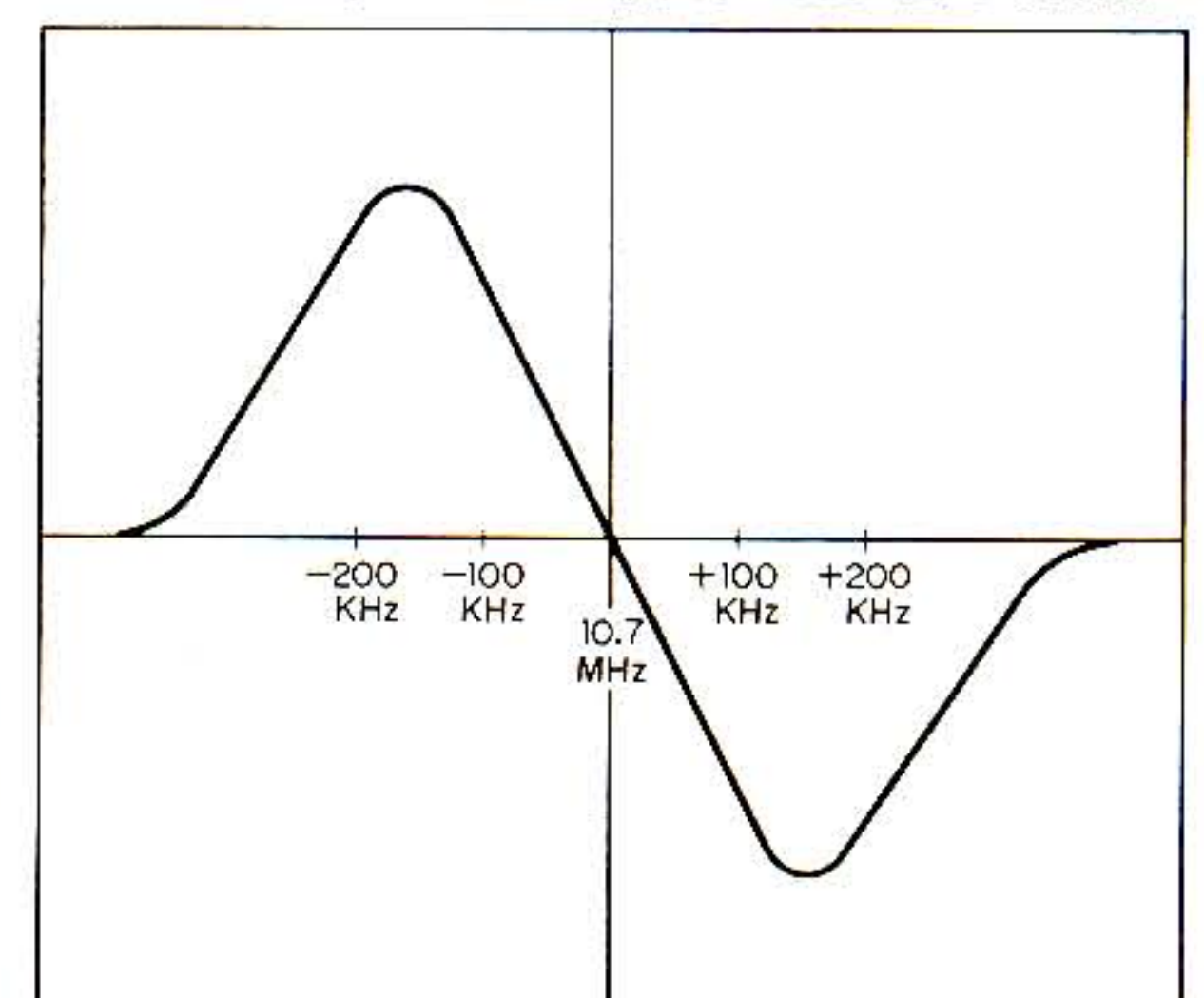

ALIGNMENT

FM MULTIPLEX ALIGNMENT PROCEDURE

1. Do not attempt to align the Multiplex Circuit unless the following equipment is available:

a. Multiplex Stereo Generator b. Oscilloscope c. AC. V.T.V.M. d. Audio Oscillator e. FM Signal Generator.

STEP	ALIGN	GENERATOR	FEED SIGNAL	OUTPUT INDICATOR	ADJUST	ADJUST FOR
1.	67 KHz Trap	67 KHz Audio Signal	Connect to TP _{4A}	V.T.V.M. at TP ₄₀₄	L ₄₀₁	Minimum
2.	71 KHz Trap	71 KHz Audio Signal	Connect to TP _{4A}	V.T.V.M. at TP ₄₀₄	L ₄₀₂	Minimum
3.	19 KHz Transformer	FM Signal Gen. Modulated 30% by STEREO Gen. sub-channel	Antenna terminals Tune to signal	V.T.V.M. and Oscilloscope at TP ₄₀₁	T ₄₀₁	Maximum
4.	19 KHz Transformer	FM Signal Gen. Modulated 30% by STEREO Gen. sub-channel	Antenna terminals Tune to signal	V.T.V.M. and Oscilloscope at TP ₄₀₂	TP ₄₀₂	Smaller peakvalues of two peakvalues
5.	38 KHz Transformer	FM Signal Gen. Modulated 30% by STEREO Gen. sub-channel	Antenna terminals Tune to signal	V.T.V.M. and Oscilloscope at TP ₄₀₃	T ₄₀₃	Smaller peakvalue of two peakvalues
6.	38 KHz Transformer and Separation VR	FM Signal Gen. Modulated 30% by STEREO Signal Gen. channel-L	Antenna terminals Tune to signal	V.T.V.M. and Oscilloscope at output load channel-R	T ₄₀₃ (MPT-20B) within 1/4 turn and Separation VR(VR ₀₀₁)	Channel-R Minimum

AM ALIGNMENT PROCEDURE

NOTE: To align, set the signal generator level to minimum.

STEP	ALIGN	GENERATOR	FEED SIGNAL	OUTPUT INDICATOR	DIAL SETTING	ADJUST	ADJUST FOR
1.	I.F. Transformer	455 KHz ± 30 KHz Sweep-generator	Antenna terminals	Oscilloscope and V.T.V.M. at 3G		top and bottom sides from the 1st I.F.T. (T ₃₀₂) to the 3rd I.F.T. (T ₃₀₄)	Best I.F.T. wave form
2.	O.S.C.	AM-generator 535 KHz 400 Hz 30% Modulation	Antenna terminals	Oscilloscope and V.T.V.M. at output load	535 KHz	O.S.C. Coil L ₃₀₂	Maximum
3.	O.S.C.	AM-generator 1600 KHz 400 Hz 30% Modulation	Antenna terminals	Oscilloscope and V.T.V.M. at output load	1600 KHz	O.S.C. Trimmer TC ₃₀₃	Maximum
4.	Reiterate 2 and 3						
5.	RF amp.	AM-generator 600 KHz 400 Hz 30% Modulation	Antenna terminals	Oscilloscope and V.T.V.M. at output load	600 KHz	RF transformer T ₃₀₁	Maximum
6.	Antenna circuit	AM-generator 600 KHz 400 Hz 30% Modulation	Antenna terminals	Oscilloscope and V.T.V.M. at output load	600 KHz	Ferrite bar Antenna L ₃₀₁	Maximum
7.	RF amp.	AM-generation 1400 KHz 400 Hz 30% Modulation	Antenna terminals	Oscilloscope and V.T.V.M. at output load	1400 KHz	RF Trimmer TC ₃₀₂	Maximum
8.	Antenna circuit	AM-generation 1400 KHz 400 Hz 30% Modulation	Antenna terminals	Oscilloscope and V.T.V.M. at output load	1400 KHz	Antenna circuit Trimmer TC ₃₀₁	Maximum
9.	Reiterate 5. 6. 7. 8.						

AM IF WAVE FORM

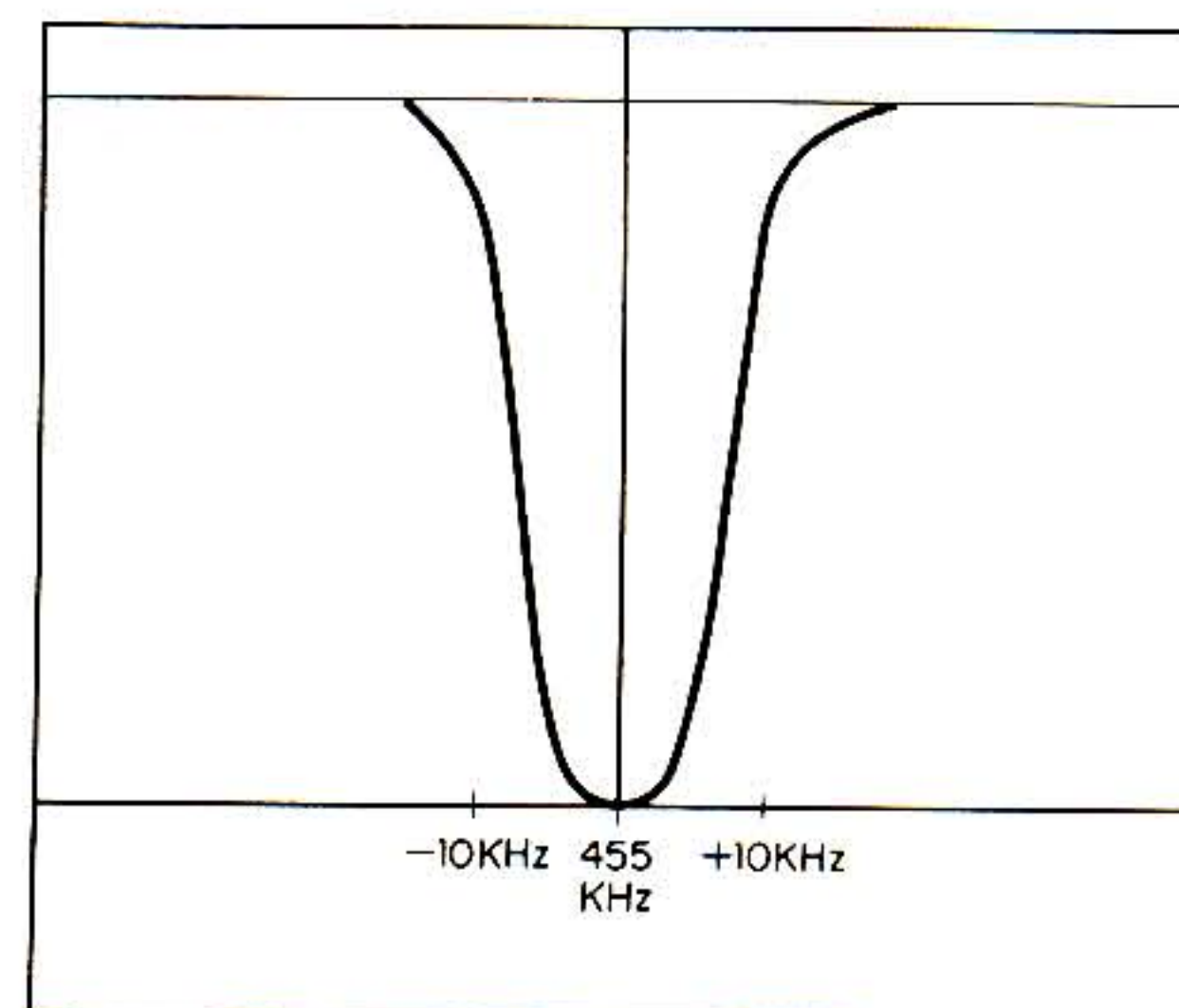

PRINTED CIRCUIT SHEETS AND PARTS LIST

F-1005 < FM IF >

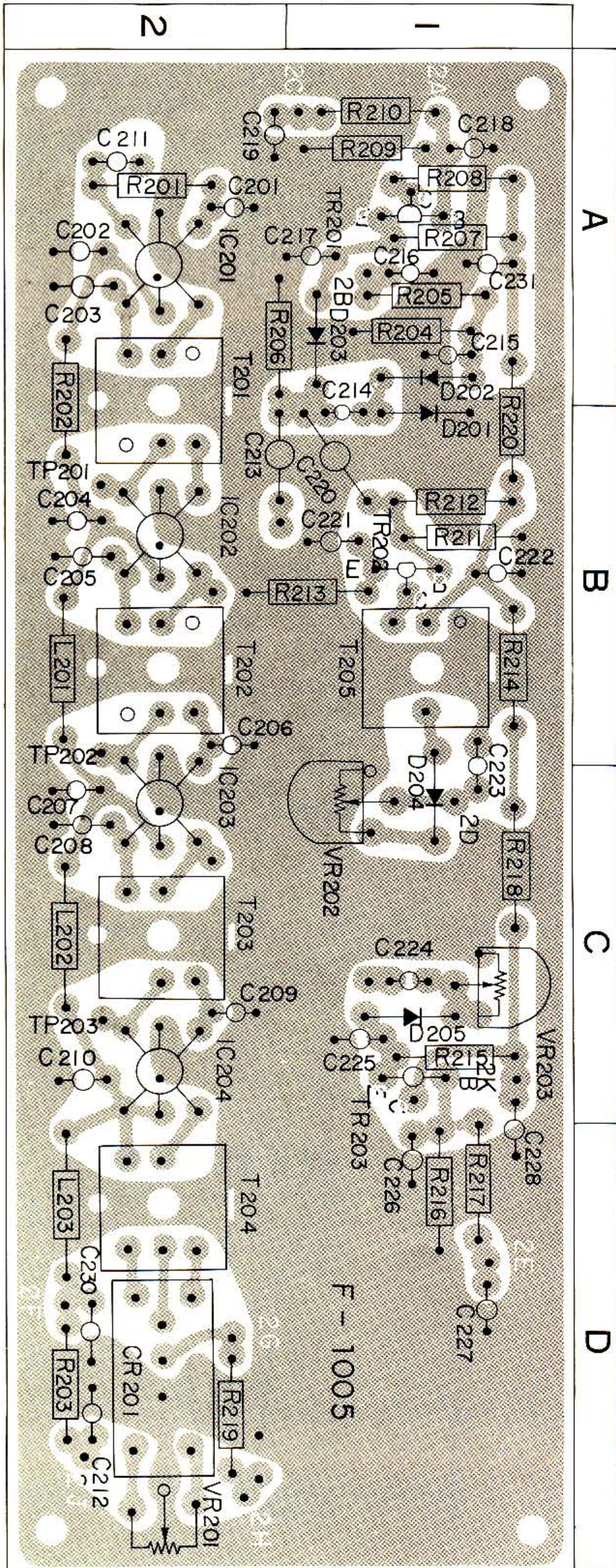

X	Y			Z	
R201	1.2K Ω	$\frac{1}{4}$ W	$\pm 10\%$	PREC. Fixed	2 A
R202	22 Ω	$\frac{1}{4}$ W	$\pm 10\%$	PREC. Fixed	2 A, B
R203	56 Ω	$\frac{1}{4}$ W	$\pm 10\%$	PREC. Fixed	2 D
R204	47K Ω	$\frac{1}{4}$ W	$\pm 10\%$	PREC. Fixed	1 A
R205	100K Ω	$\frac{1}{4}$ W	$\pm 10\%$	PREC. Fixed	1 A
R206	100K Ω	$\frac{1}{4}$ W	$\pm 10\%$	PREC. Fixed	2 A
R207	200K Ω	$\frac{1}{4}$ W	$\pm 10\%$	PREC. Fixed	1 A
R208	1K Ω	$\frac{1}{4}$ W	$\pm 10\%$	PREC. Fixed	1 A
R209	2.2K Ω	$\frac{1}{4}$ W	$\pm 10\%$	PREC. Fixed	1 A
R210	1K Ω	$\frac{1}{4}$ W	$\pm 10\%$	PREC. Fixed	1 A
R211	10K Ω	$\frac{1}{4}$ W	$\pm 10\%$	PREC. Fixed	1 B
R212	22K Ω	$\frac{1}{4}$ W	$\pm 10\%$	PREC. Fixed	1 B
R213	1K Ω	$\frac{1}{4}$ W	$\pm 10\%$	PREC. Fixed	1, 2 B
R214	22K Ω	$\frac{1}{4}$ W	$\pm 10\%$	PREC. Fixed	1 B
R215	220K Ω	$\frac{1}{4}$ W	$\pm 10\%$	PREC. Fixed	1 C
R216	2.2K Ω	$\frac{1}{4}$ W	$\pm 10\%$	PREC. Fixed	1 D
R217	1K Ω	$\frac{1}{4}$ W	$\pm 10\%$	PREC. Fixed	1 D
R218	22 Ω	$\frac{1}{4}$ W	$\pm 10\%$	PREC. Fixed	1 C
R219	22K Ω	$\frac{1}{4}$ W	$\pm 10\%$	PREC. Fixed	2 D
R220	22 Ω	$\frac{1}{4}$ W	$\pm 10\%$	PREC. Fixed	1 A, B
CR201				(080016)	2 D
C201	0.02 μ F	50 VDCW.		CER.	2 A
C202	0.02 μ F	50 VDCW.		CER.	2 A
C203	0.02 μ F	50 VDCW.		CER.	2 A
C204	0.02 μ F	50 VDCW.		CER.	3 B
C205	0.02 μ F	50 VDCW.		CER.	3 B
C206	0.02 μ F	50 VDCW.		CER.	3 B
C207	0.02 μ F	50 VDCW.		CER.	3 C
C208	0.02 μ F	50 VDCW.		CER.	2 C
C209	0.02 μ F	50 VDCW.		CER.	2 C
C210	0.02 μ F	50 VDCW.		CER.	2 C
C211	0.02 μ F	50 VDCW.		CER.	2 A
C212	0.05 μ F	50 VDCW.		CER.	2 D
C213	7 pF	50 VDCW.		CER.	1, 2 B
C214	100 pF	50 VDCW.		CER.	1 A, B
C215	100 pF	50 VDCW.		CER.	1 A
C216	0.02 μ F	50 VDCW.		CER.	1 A
C217	0.02 μ F	50 VDCW.		CER.	1 A
C218	0.02 μ F	50 VDCW.		CER.	1 A
C219	0.02 μ F	50 VDCW.		CER.	2 A
C220	50 pF	50 VDCW.		CER.	1 B
C221	0.02 μ F	50 VDCW.		CER.	1 B
C222	0.02 μ F	50 VDCW.		CER.	1 B
C223	1000 pF	50 VDCW.		CER.	1 B, C
C224	2 pF	50 VDCW.		CER.	1 C
C225	0.02 μ F	50 VDCW.		CER.	1 C
C226	0.02 μ F	50 VDCW.		CER.	1 D
C227	0.02 μ F	50 VDCW.		CER.	1 D
C228	0.05 μ F	50 VDCW.		CER.	1 C, D
C230	0.05 μ F	50 VDCW.		CER.	2 D
C231	0.05 μ F	50 VDCW.		CER.	1 A
TR201	2SC536(G) or (2SC828T) Si N-P-N				1 A
TR202	2SC380(O) or (2SC829) Si N-P-N				1 B
TR203	2SC536(G) or (2SC828T) Si N-P-N				1 C

X: Parts No.
Y: Parts Name
Z: Co-ordinates in Prited Circuit Sheets

X	Y	Z
IC201	μ A703E (036001)	2 A
IC202	μ A703E (036001)	2 B
IC203	μ A703E (036001)	2 C
IC204	μ A703E (036001)	2 C
T201	FM IF 10.7MHz (423519)	2 A, B
T202	FM IF 10.7MHz (423519)	2 B
T203	FM IF 10.7MHz (423520)	2 C
T204	FM IF 10.7MHz (423518)	2 D
T205	10.7MHz Tuning trap (423521)	1 B
D201	IN60 (031033)	1 B
D202	IN60 (031033)	1 A
D203	IN60 (031033)	1 A
D204	IN60 (031033)	1 C
D205	IN60 (031033)	1 C
VR201	10K Ω (B) (103019)	2 D
VR202	50K Ω (B) (103020)	1 C
VR203	250K Ω (B) (103036)	1 C
L201	3.5 μ H (429001)	2 B
L202	3.5 μ H (429001)	2 C
L203	3.5 μ H (429001)	2 D

F-1120 ◀ MUTING ▶

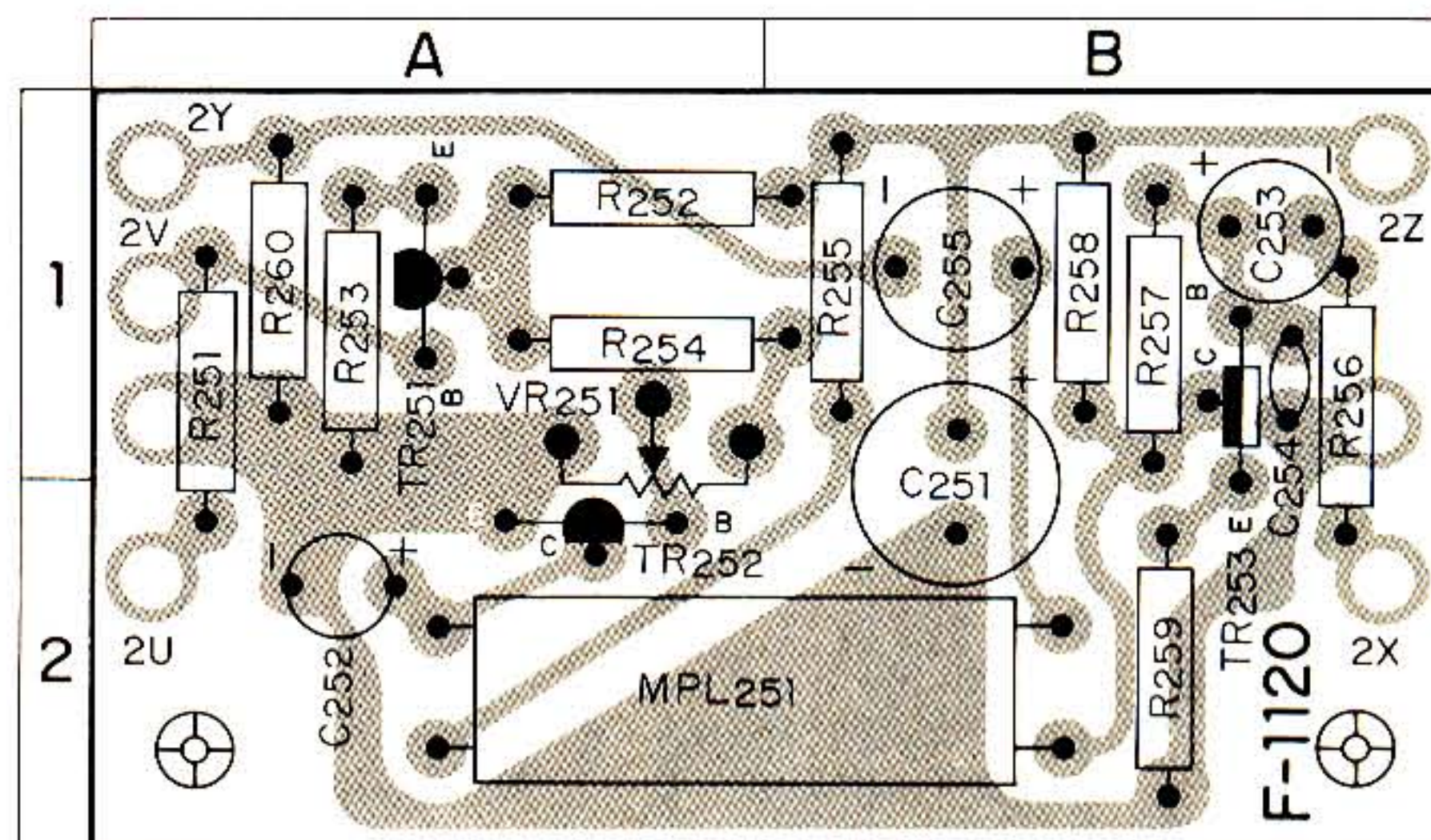

X	Y	Z
R251	2.2K Ω 1/4W \pm 10% Carbon Fixed	1 A
R252	4.7K Ω 1/4W \pm 10% Carbon Fixed	1 A
R253	680 Ω 1/4W \pm 10% Carbon Fixed	1 A
R254	5.6K Ω 1/4W \pm 10% Carbon Fixed	1 A
R255	270 Ω 1/4W \pm 10% Carbon Fixed	1 B
R256	1K Ω 1/4W \pm 10% Carbon Fixed	1 B
R257	220K Ω 1/4W \pm 10% Carbon Fixed	1 B
R258	4.7K Ω 1/4W \pm 10% Carbon Fixed	1 B
R259	1K Ω 1/4W \pm 10% Carbon Fixed	2 B
R260	4.7 Ω 1/4W \pm 10% Carbon Fixed	1 A
C251	47 μ F 16 VDCW. ELECT.	2 B
C252	1 μ F 50 VDCW. ELECT.	1 A
C253	3.3 μ F 25 VDCW. ELECT.	1 B
C254	100 μ F \pm 20% 50 VDCW. CER.	1 B
C255	10 μ F 25 VDCW. ELECT.	1 B
MPL251	Cds	2 B
TR251	2SC828T TR (030527)	1 A
TR252	2SC828T TR (030527)	2 A
TR253	2SC458LB TR (030511-1)	2 B
VR001	5K Ω (B) Semi-Variable (103037)	1 A

PRINTED CIRCUIT SHEETS AND PARTS LIST

F-1006 < MULTIPLEX >

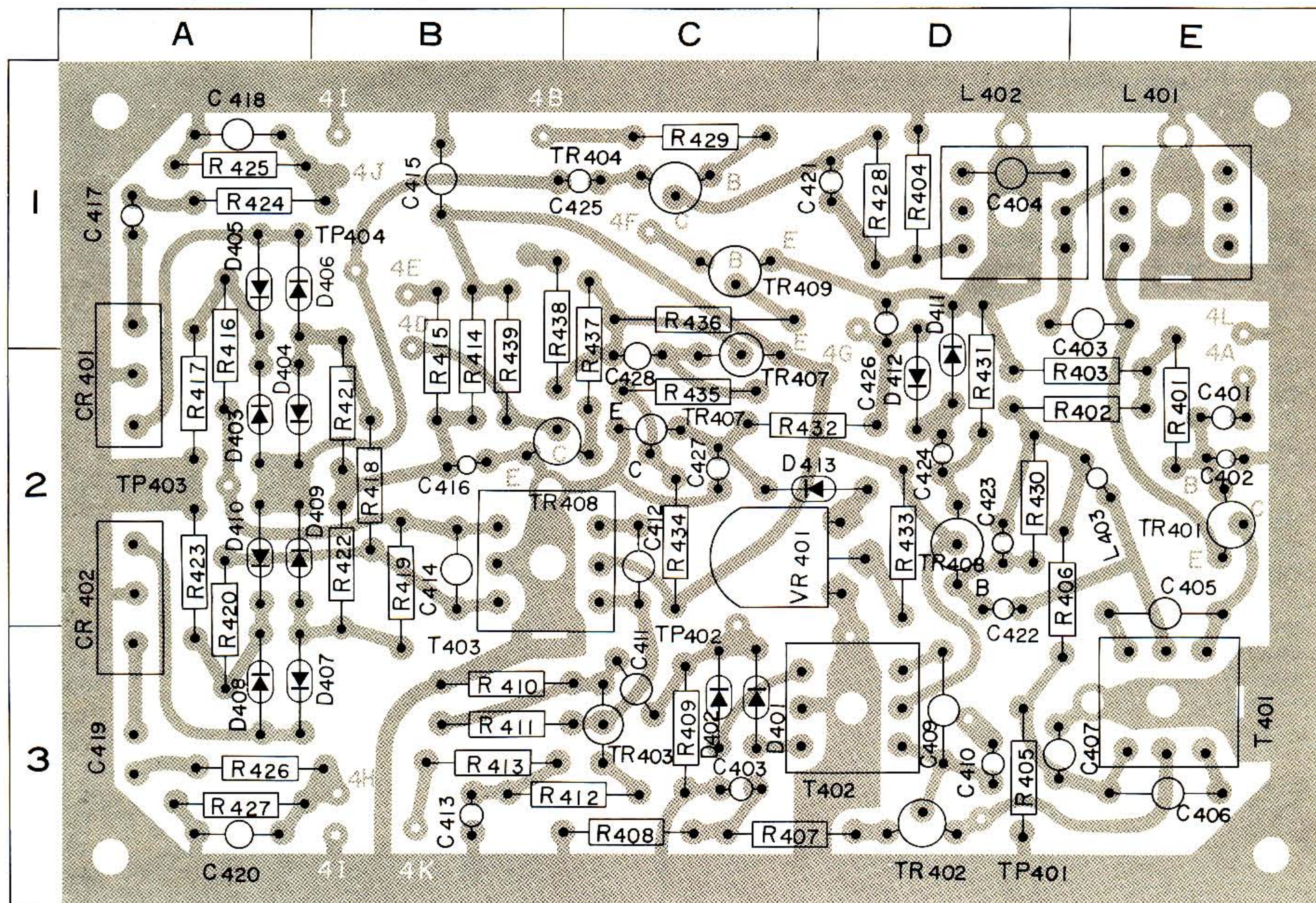

X: Parts No.
Y: Parts Name
Z: Co-ordinates in Printed Circuit Sheets

X	Y				Z
R401	47KΩ	¼W	±10%	PREC. Fixed	2 E
R402	120KΩ	¼W	±10%	PREC. Fixed	2 D, E
R403	100KΩ	¼W	±10%	PREC. Fixed	2 D, E
R404	2.2KΩ	¼W	±10%	PREC. Fixed	1 D
R405	27KΩ	¼W	±10%	PREC. Fixed	3 D
R406	330KΩ	¼W	±10%	PREC. Fixed	2 D, E
R407	330KΩ	¼W	±10%	PREC. Fixed	3 C, D
R408	1.2KΩ	¼W	±10%	PREC. Fixed	3 C
R409	10KΩ	¼W	±10%	PREC. Fixed	3 C
R410	27KΩ	¼W	±10%	PREC. Fixed	3 B
R411	270KΩ	¼W	±10%	PREC. Fixed	3 B
R412	470Ω	¼W	±10%	PREC. Fixed	3 B, C
R413	1.2KΩ	¼W	±10%	PREC. Fixed	3 B
R414	33KΩ	¼W	±10%	PREC. Fixed	1, 2 B
R415	10KΩ	¼W	±10%	PREC. Fixed	1, 2 B
R416	33KΩ	¼W	±10%	PREC. Fixed	1, 2 A
R417	100KΩ	¼W	±10%	PREC. Fixed	2 A
R418	33KΩ	¼W	±10%	PREC. Fixed	2 B
R419	33KΩ	¼W	±10%	PREC. Fixed	2 B
R420	33KΩ	¼W	±10%	PREC. Fixed	2, 3 A
R421	100KΩ	¼W	±10%	PREC. Fixed	2 B
R422	100KΩ	¼W	±10%	PREC. Fixed	2 B
R423	100KΩ	¼W	±10%	PREC. Fixed	2 A
R424	330KΩ	¼W	±10%	PREC. Fixed	1 A
R425	180KΩ	¼W	±10%	PREC. Fixed	1 A
R426	330KΩ	¼W	±10%	PREC. Fixed	3 A
R427	180KΩ	¼W	±10%	PREC. Fixed	3 A
R428	39KΩ	¼W	±10%	PREC. Fixed	1 D
R429	22KΩ	¼W	±10%	PREC. Fixed	1 C
R430	820KΩ	¼W	±10%	PREC. Fixed	2 D
R431	10KΩ	¼W	±10%	PREC. Fixed	2 D
R432	220KΩ	¼W	±10%	PREC. Fixed	2 D
R434	10KΩ	¼W	±10%	PREC. Fixed	2 C
R435	22KΩ	¼W	±10%	PREC. Fixed	2 C
R436	5.6KΩ	¼W	±10%	PREC. Fixed	1 C
R437	33KΩ	¼W	±10%	PREC. Fixed	1, 2 C
R438	10KΩ	¼W	±10%	PREC. Fixed	1, 2 B
R439	6.8KΩ	¼W	±10%	PREC. Fixed	1, 2 B
VR401	200KΩ(B)	(103035)			2 C, D
C401	10μF	15 VDCW.	ELECT.		2 E
C402	50 pF	50 VDCW.	CER.		2 E
C403	2800 pF	50 VDCW.	CER.		1 D, E
C404	120 pF	50 VDCW.	CER.		1 D
C405	6800 pF	50 VDCW.	CER.		2 E
C406	6800 pF	50 VDCW.	CER.		3 E
C407	0.05μF	50 VDCW.	CER.		3 D
C408	1μF	25 VDCW.	ELECT.		3 C
C409	6800 pF	50 VDCW.	CER.		3 D
C410	0.002μF	50 VDCW.	CER.		3 D
C411	0.05μF	50 VDCW.	CER.		3 C
C412	1700 pF	50 VDCW.	CER.		2 C
C413	1μF	25 VDCW.	ELECT.		3 B
C414	1700 pF	50 VDCW.	CER.		2 B
C415	200μF	25 VDCW.	CER.		1 B

X	Y			Z
C416	10μF	25 VDCW.	CER.	2 B
C417	0.33μF	25 VDCW.	ELECT.	1 A
C418	750 pF	50 VDCW.	CER.	1 A
C419	0.33μF	25 VDCW.	CER.	3 A
C420	750 pF	50 VDCW.	CER.	3 A
C421	10μF	25 VDCW.	ELECT.	1 D
C422	0.005μF	50 VDCW.	CER.	2 D
C423	100 PF	50 VDCW.	CER.	2 D
C424	0.005μF	50 VDCW.	CER.	2 D
C425	10μF	25 VDCW.	ELECT.	1 C
C426	0.005μF	25 VDCW.	CER.	1 D
C427	1μF	25 VDCW.	ELECT.	2 C
C428	0.03μF	50 VDCW.	CER.	1, 2 C
TR401	2SC536V ₁ E ₂	Si N-P-N		2 E
TR402	2SC536V ₁ E ₂	Si N-P-N		3 D
TR403	2SC536V ₁ E ₂	Si N-P-N		3 C
TR404	2SC536V ₁ G ₂ or 2SC828T	Si N-P-N		1 C
TR405	2SC536V ₁ E ₂	Si N-P-N		2 D
TR406	2SC373	Si N-P-N		1 C
TR407	2SA564A	Ge P-N-P		1, 2 C
TR408	2SC373	Si N-P-N		2 B, C
TR409	2SC696(D & A)	Si N-P-N		1 C
D401	1N34A			3 C
D402	1N34A			3 C
D403	1N34A			2 A
D404	1N34A			2 A
D405	1N34A			1 A
D406	1N34A			1 A
D407	1N34A			3 B
D408	1N34A			3 A
D409	1N34A			2 A
D410	1N34A			2 A
D411	1N34A			1, 2 D
D412	1N34A			1, 2 D
D413	1N34A			2 C, D
T401	19KHz	Tuning Trap (424021)		3 E
T402	19KHz	Tuning Trap (424022)		3 C, D
T403	38KHz	Tuning Trap (424023)		2 B, C
L401	67KHz	Filter (424024)		1 E
L402	71KHz	Filter (424025)		1 D, E
L403	19KHz	Filter (490003)		2 E
CR401	38KHz	Filter & de emphasis (080008)		1, 2 A
CR401	38KHz	Filter & de emphasis (080008)		2, 3 A

PRINTED CIRCUIT SHEETS AND PARTS LIST

F-1036 <EQUALIZER AMP.>

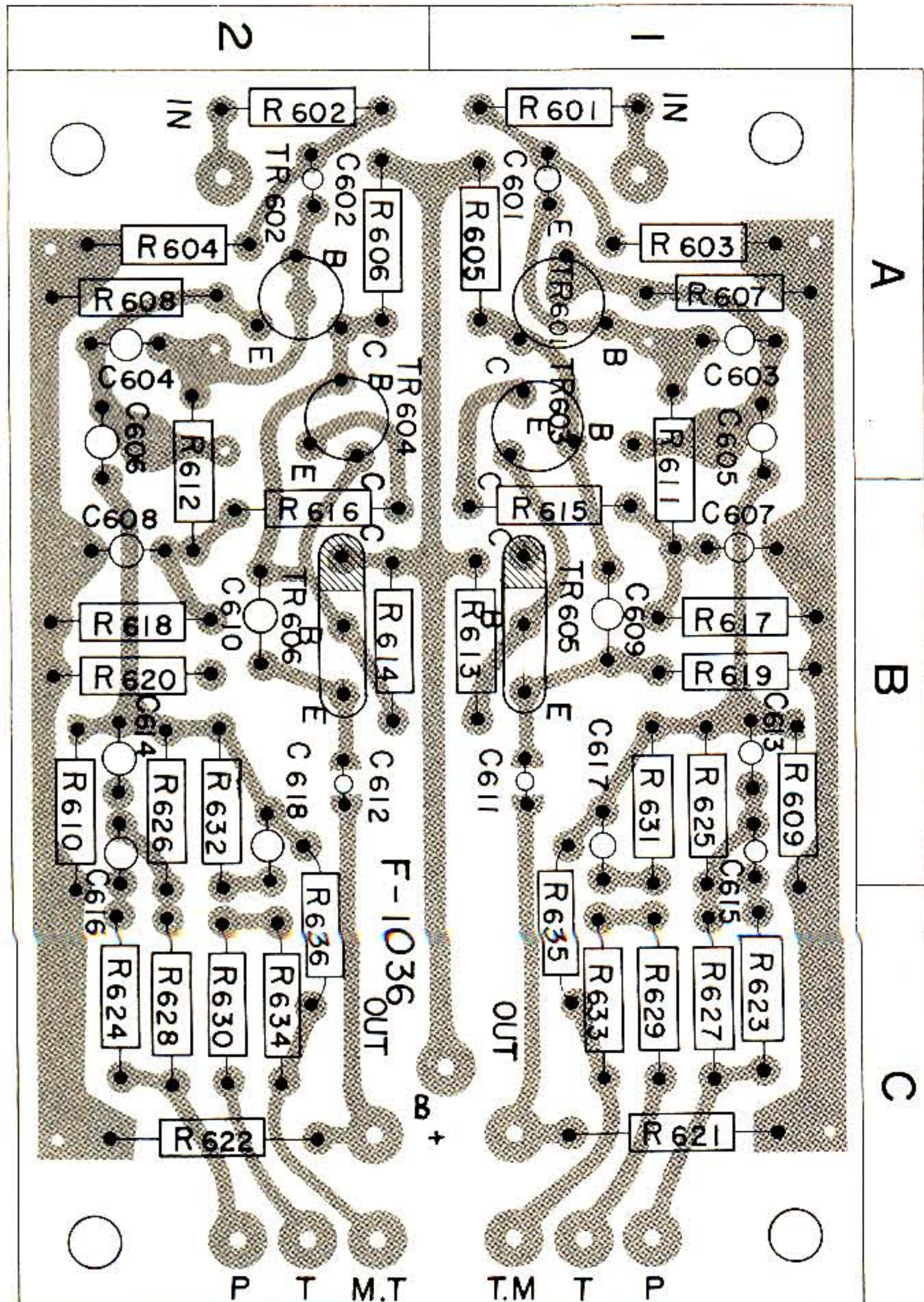

X	Y				Z
R605	220KΩ	¼W	±10%	PREC. Fixed	1 A
R606	220KΩ	¼W	±10%	PREC. Fixed	1 A
R607	1KΩ	¼W	±10%	PREC. Fixed	1 A
R608	1KΩ	¼W	±10%	PREC. Fixed	1 A
R609	470Ω	¼W	±10%	PREC. Fixed	1 B
R610	470Ω	¼W	±10%	PREC. Fixed	1 B
R611	270KΩ	¼W	±10%	PREC. Fixed	1 A, B
R612	270KΩ	¼W	±10%	PREC. Fixed	1 A, B
R613	33KΩ	¼W	±10%	PREC. Fixed	1 B
R614	33KΩ	¼W	±10%	PREC. Fixed	1 B
R615	680Ω	¼W	±10%	PREC. Fixed	1 B
R616	680Ω	¼W	±10%	PREC. Fixed	1 B
R617	2.2KΩ	¼W	±10%	PREC. Fixed	1 B
R618	2.2KΩ	¼W	±10%	PREC. Fixed	1 B
R619	3.9KΩ	¼W	±10%	PREC. Fixed	1 B
R620	3.9KΩ	¼W	±10%	PREC. Fixed	1 B
R621	39KΩ	¼W	±10%	PREC. Fixed	1 C
R622	39KΩ	¼W	±10%	PREC. Fixed	1 C
R623	820Ω	¼W	±10%	PREC. Fixed	1 C
R624	820Ω	¼W	±10%	PREC. Fixed	1 C
R625	220KΩ	¼W	±10%	PREC. Fixed	1 B
R626	220KΩ	¼W	±10%	PREC. Fixed	1 B
R627	18KΩ	¼W	±10%	PREC. Fixed	1 C
R628	18KΩ	¼W	±10%	PREC. Fixed	1 C
R629	10KΩ	¼W	±10%	PREC. Fixed	1 C
R630	10KΩ	¼W	±10%	PREC. Fixed	1 C
R631	680KΩ	¼W	±10%	PREC. Fixed	1 B
R632	680KΩ	¼W	±10%	PREC. Fixed	1 B
R635	4.7KΩ	¼W	±10%	PREC. Fixed	1 C
R636	4.7KΩ	¼W	±10%	PREC. Fixed	1 C
C601	1.5μF		10 VDCW.	Ta.	1 A
C602	1.5μF		10 VDCW.	Ta.	1 A
C603	150 pF	±10%	50 VDCW.	CER.	1 A
C604	150 pF	±10%	50 VDCW.	CER.	1 A
C605	220μF		6.3 VDCW.	ELECT.	1 A
C606	220μF		6.3 VDCW.	ELECT.	1 A
C607	10μF		10 VDCW.	ELECT.	1 B
C608	10μF		10 VDCW.	ELECT.	1 B
C609	30 pF	±10%	50 VDCW.		1 B
C610	30 pF	±10%	50 VDCW.		1 B
C611	10μF		25 VDCW.	ELECT.	1 B
C612	10μF		25 VDCW.	ELECT.	1 B
C613	0.015μF	±10%	50 VDCW.	My.	1 B
C614	0.004 pF	±10%	50 VDCW.	My.	1 B
C615	0.004 pF	±10%	50 VDCW.	My.	1 B
C616	0.005 pF	±10%	50 VDCW.	My.	1 B
C617	0.0047 pF	±10%	50 VDCW.	My.	1 B
C618	0.0047 pF	±10%	50 VDCW.	My.	1 B
TR601	2SC650 or (2SC631)		Si N-P-N		1 A
TR602	2SC650 or (2SC531)		Si N-P-N		2 A
TR603	2SC281 or (2SC531)		Si N-P-N		1 A
TR604	2SC281 or (2SC531)		Si N-P-N		2 A
TR605	2SC281 or (2SC631)		Si N-P-N		1 B
TR606	2SC281 or (2SC631)		Si N-P-N		2 B

X	Y				Z
R601	1KΩ	¼W	±10%	PREC. Fixed	1 A
R602	1KΩ	¼W	±10%	PREC. Fixed	1 A
R603	680KΩ	¼W	±10%	PREC. Fixed	1 A
R604	680KΩ	¼W	±10%	PREC. Fixed	1 A

X: Parts No.
 Y: Parts Name
 Z: Co-ordinates in Printed Circuit Sheets

F-1040 < DRIVER AMP. >

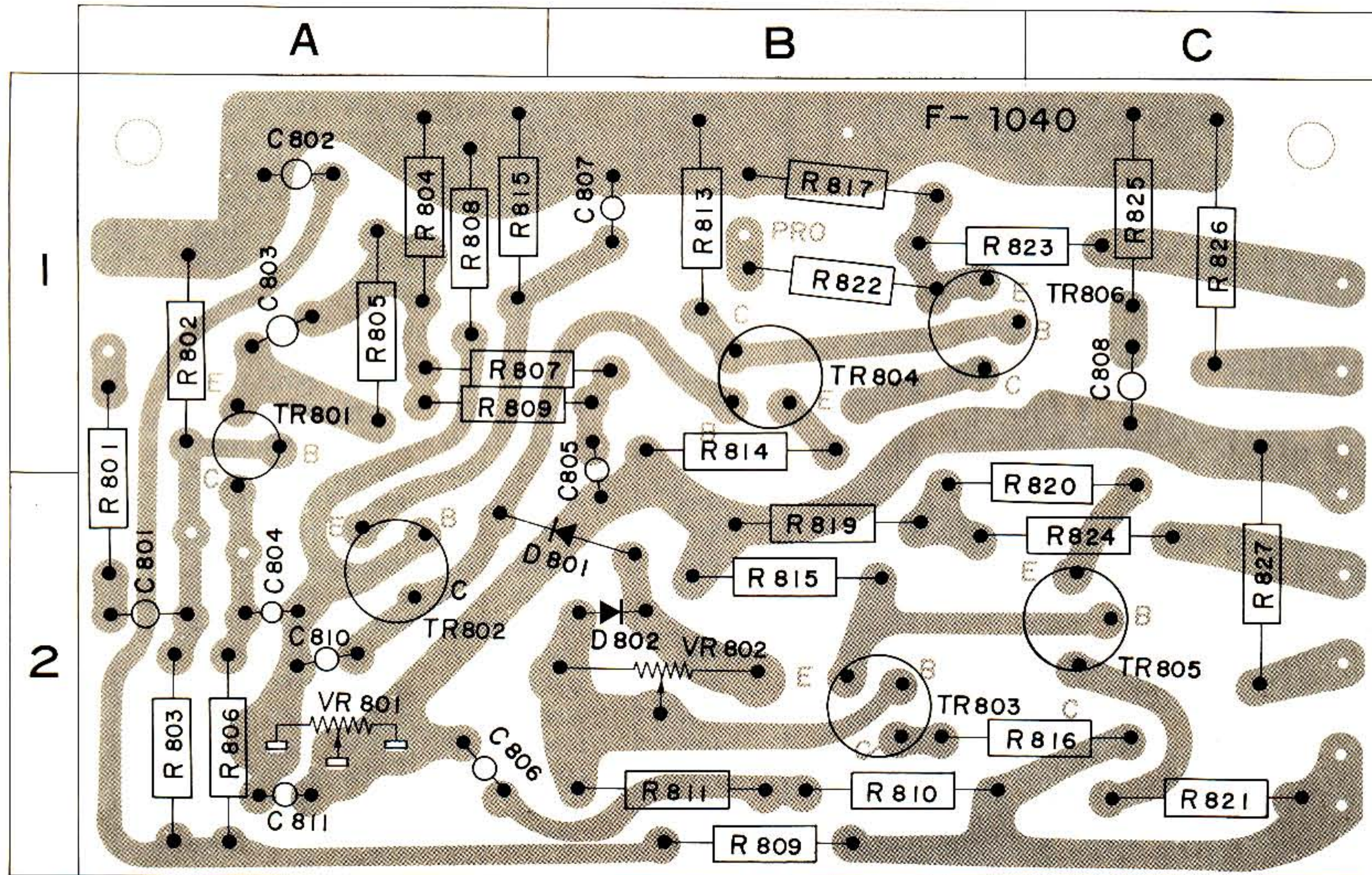

X	Y				Z
R801	2.2K Ω	1/4W	$\pm 10\%$	COMP. Fixed	1, 2 A
R802	220K Ω	1/4W	$\pm 10\%$	COMP. Fixed	1 A
R803	560K Ω	1/4W	$\pm 10\%$	COMP. Fixed	2 A
R804	220 Ω	1/4W	$\pm 10\%$	COMP. Fixed	1 A
R805	2.2K Ω	1/4W	$\pm 10\%$	COMP. Fixed	1 A
R806	2.7K Ω	1/4W	$\pm 10\%$	COMP. Fixed	2 A
R807	6.8K Ω	1/4W	$\pm 10\%$	COMP. Fixed	1 A, B
R808	10K Ω	1/4W	$\pm 10\%$	COMP. Fixed	1 A
R809	47K Ω	1/4W	$\pm 10\%$	COMP. Fixed	1 A, B
R810	1K Ω	1/4W	$\pm 10\%$	COMP. Fixed	
R811	3.3K Ω	1/4W	$\pm 10\%$	COMP. Fixed	
R812	220 Ω	1/4W	$\pm 10\%$	COMP. Fixed	
R813	120 Ω	1/4W	$\pm 10\%$	COMP. Fixed	1 B
R814	4.7 Ω	1/4W	$\pm 10\%$	COMP. Fixed	1 B
R815	120 Ω	1/4W	$\pm 10\%$	COMP. Fixed	1 A
R816	33 Ω	1/4W	$\pm 10\%$	COMP. Fixed	
R817	100 Ω	1/4W	$\pm 10\%$	COMP. Fixed	
R818	3.3 Ω	1/4W	$\pm 10\%$	COMP. Fixed	
R819	100 Ω	1/4W	$\pm 10\%$	COMP. Fixed	
R820	4.7 Ω	1/4W	$\pm 10\%$	COMP. Fixed	
R821	3.3 Ω	1/4W	$\pm 10\%$	COMP. Fixed	
R822	1K Ω	1/4W	$\pm 10\%$	COMP. Fixed	1 B
R823	3.3 Ω	1/4W	$\pm 10\%$	COMP. Fixed	1 B, C
R824	3.3 Ω	1/4W	$\pm 10\%$	COMP. Fixed	
R825	22 Ω	1/4W	$\pm 10\%$	COMP. Fixed	

X	Y				Z
R826	0.3 Ω	1 W	$\pm 10\%$	WW.	
R827	0.3 Ω	1 W		COMP. Fixed	2 C
VR801	500K Ω (B)	(103050)			2 A
VR802	500 Ω (B)	(103051)			2 B
C801	0.5 μ F	50 VDCW.		My.	2 A
C802	100 μ F	35 VDCW.		ELECT.	1 A
C803	220 μ F	15 VDCW.		ELECT.	1 A
C804	1 μ F	50 VDCW.		Ta.	2 A
C805	10 μ F	50 VDCW.		ELECT.	1 B
C806	33 μ F	50 VDCW.		ELECT.	2 A
C807	47 μ F	15 VDCW.		ELECT.	1 B
C808	0.05 μ F	50 VDCW.		CER.	1 C
C809	100 pF	50 VDCW.		CER.	1 A, B
C810	100 pF	50 VDCW.		CER.	2 A
TR801	2SC458LG(C)	Si N-P-N			1 A
TR802	2SC756	Si N-P-N			2 A
TR803	2SC485	Si N-P-N			2 B
TR804	2SA485	Si N-P-N			1 B
TR805	2SC756	Si N-P-N			2 C
TR806	2SC756	Si N-P-N			1 B, C
D801	LV-2	Si diode			2 A, B
D802	LV-2	Si diode			2 B

PRINTED CIRCUIT SHEETS AND PARTS LIST

F-1029 < TONE CONTROL >

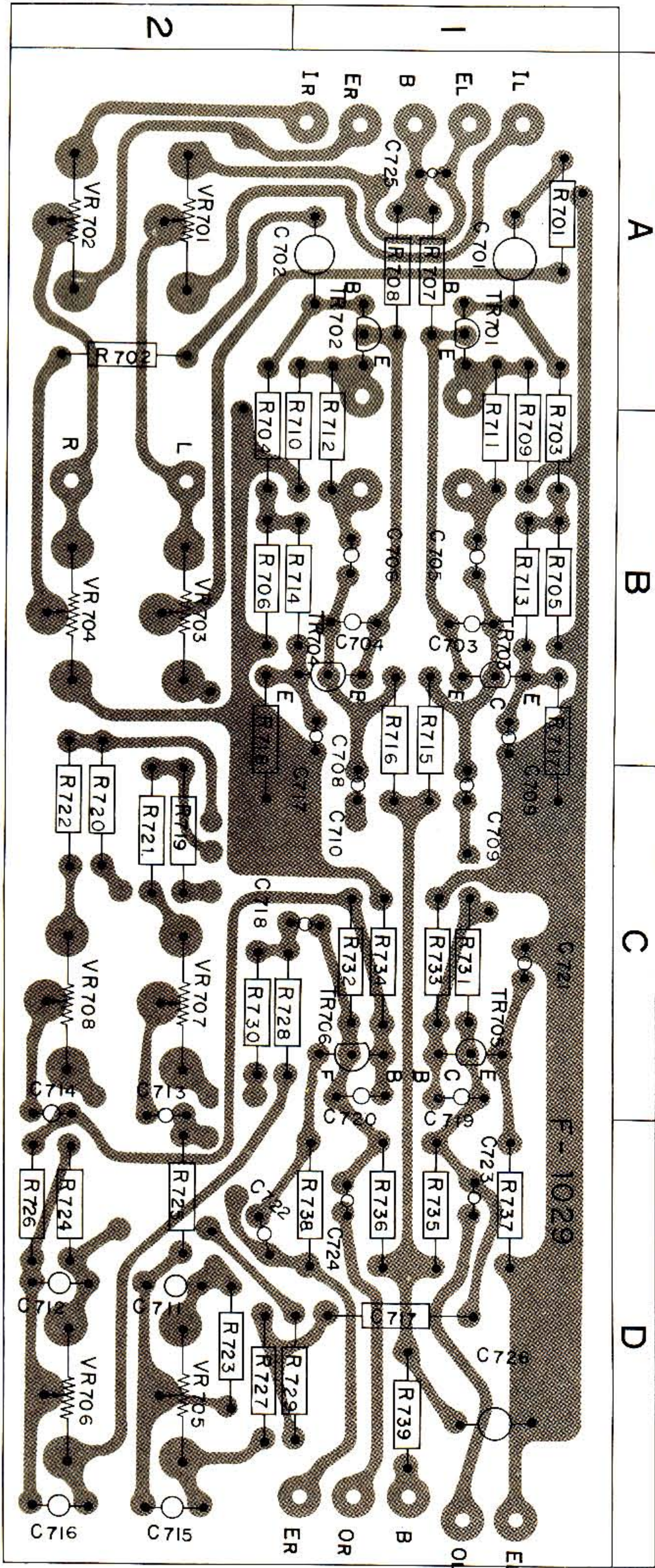

X	Y			Z	
R701	1KΩ	¼W	±10%	PREC. Fixed	2A
R702	1KΩ	¼W	±10%	PREC. Fixed	1A
R703	47KΩ	¼W	±10%	PREC. Fixed	2A, B
R704	47KΩ	¼W	±10%	PREC. Fixed	1A, B
R705	68KΩ	¼W	±10%	PREC. Fixed	2B
R706	68KΩ	¼W	±10%	PREC. Fixed	1B
R707	100KΩ	¼W	±10%	PREC. Fixed	1A
R708	100KΩ	¼W	±10%	PREC. Fixed	1A
R709	1KΩ	¼W	±10%	PREC. Fixed	1A, B
R710	1KΩ	¼W	±10%	PREC. Fixed	1A, B
R711	8.2KΩ	¼W	±10%	PREC. Fixed	1A, B
R712	8.2KΩ	¼W	±10%	PREC. Fixed	1A, B
R713	120KΩ	¼W	±10%	PREC. Fixed	1B
R714	120KΩ	¼W	±10%	PREC. Fixed	1B
R715	15KΩ	¼W	±10%	PREC. Fixed	2B
R716	15KΩ	¼W	±10%	PREC. Fixed	1B, C
R717	2.7KΩ	¼W	±10%	PREC. Fixed	2B, C
R718	2.7KΩ	¼W	±10%	PREC. Fixed	1B, C
R719	10KΩ	¼W	±10%	PREC. Fixed	2C
R720	10KΩ	¼W	±10%	PREC. Fixed	2C
R721	6.8KΩ	¼W	±10%	PREC. Fixed	2C
R722	6.8KΩ	¼W	±10%	PREC. Fixed	2C
R723	150KΩ	¼W	±10%	PREC. Fixed	2D
R724	150KΩ	¼W	±10%	PREC. Fixed	2D
R725	22KΩ	¼W	±10%	PREC. Fixed	2D
R726	22KΩ	¼W	±10%	PREC. Fixed	2D
R727	10KΩ	¼W	±10%	PREC. Fixed	12C
R728	10KΩ	¼W	±10%	PREC. Fixed	2D
R729	6.8KΩ	¼W	±10%	PREC. Fixed	2C
R730	6.8KΩ	¼W	±10%	PREC. Fixed	1D
R731	470KΩ	¼W	±10%	PREC. Fixed	1C
R732	470KΩ	¼W	±10%	PREC. Fixed	1C
R733	150KΩ	¼W	±10%	PREC. Fixed	1C
R734	150KΩ	¼W	±10%	PREC. Fixed	1C
R735	5.6KΩ	¼W	±10%	PREC. Fixed	1D
R736	5.6KΩ	¼W	±10%	PREC. Fixed	1D
R737	560Ω	¼W	±10%	PREC. Fixed	1D
R738	560Ω	¼W	±10%	PREC. Fixed	1D
R739	100Ω	¼W	±10%	PREC. Fixed	1D
C701	0.2μF	50 VDCW.	My.		1A
C702	0.2μF	50 VDCW.	My.		1A
C703	20 pF	50 VDCW.	CER.		1B
C704	20 pF	50 VDCW.	CER.		1B
C705	30μF	15 VDCW.	ELECT.		1B
C706	30μF	15 VDCW.	ELECT.		1B
C707	30μF	15 VDCW.	ELECT.		1B
C708	30μF	15 VDCW.	ELECT.		1B, C
C709	3μF	25 VDCW.	ELECT.		1B
C710	3μF	25 VDCW.	ELECT.		1B, C
C711	0.04μF	50 VDCW.	My.		2D
C712	0.04μF	50 VDCW.	My.		2D
C713	0.0015μF	50 VDCW.	My.		2C
C714	0.0015μF	50 VDCW.	My.		2C
C715	0.04μF	50 VDCW.	My.		2D
C716	0.04μF	50 VDCW.	My.		2D

X: Parts No.
Y: Parts Name
Z: Co-ordinates in Printed Circuit Sheets

X	Y			Z
C717	3 μ F	25 VDCW.	ELECT.	1 C
C718	3 μ F	25 VDCW.	ELECT.	1 D
C719	80 pF	50 VDCW.	CER.	1 C
C720	80 pF	50 VDCW.	CER.	1 C
C721	30 μ F	15 VDCW.	ELECT.	2 D
C722	30 μ F	15 VDCW.	ELECT.	1 C
C723	1 μ F	50 VDCW.	ELECT.	1 D
C724	1 μ F	50 VDCW.	ELECT.	1 D
C725	0.47 μ F	25 VDCW.	ELECT.	1 A
C726	200 pF	25 VDCW.	ELECT.	1 D
VR701	250K(M)	Balance Control (101021)		2 A
VR702	250K(N)			
VR703	250K(B)	Main Control (101020)		2 B
VR704	250K(B)			
VR705	100K(B)	Bass Control (102004)		2 D
VR706	100K(B)			
VR707	100K(B)	Treble Control (102004)		2 C
VR708	100K(B)			
TR701	2SC693F	Si N-P-N		1 A
TR702	2SC693F	Si N-P-N		1 A
TR703	2SC536E	Si N-P-N		1 B
TR704	2SC536E	Si N-P-N		1 B
TR705	2SC871D	Si N-P-N		1 C
TR706	2SC871D	Si N-P-N		1 C

F-1137 < RIPPLE FILTER >

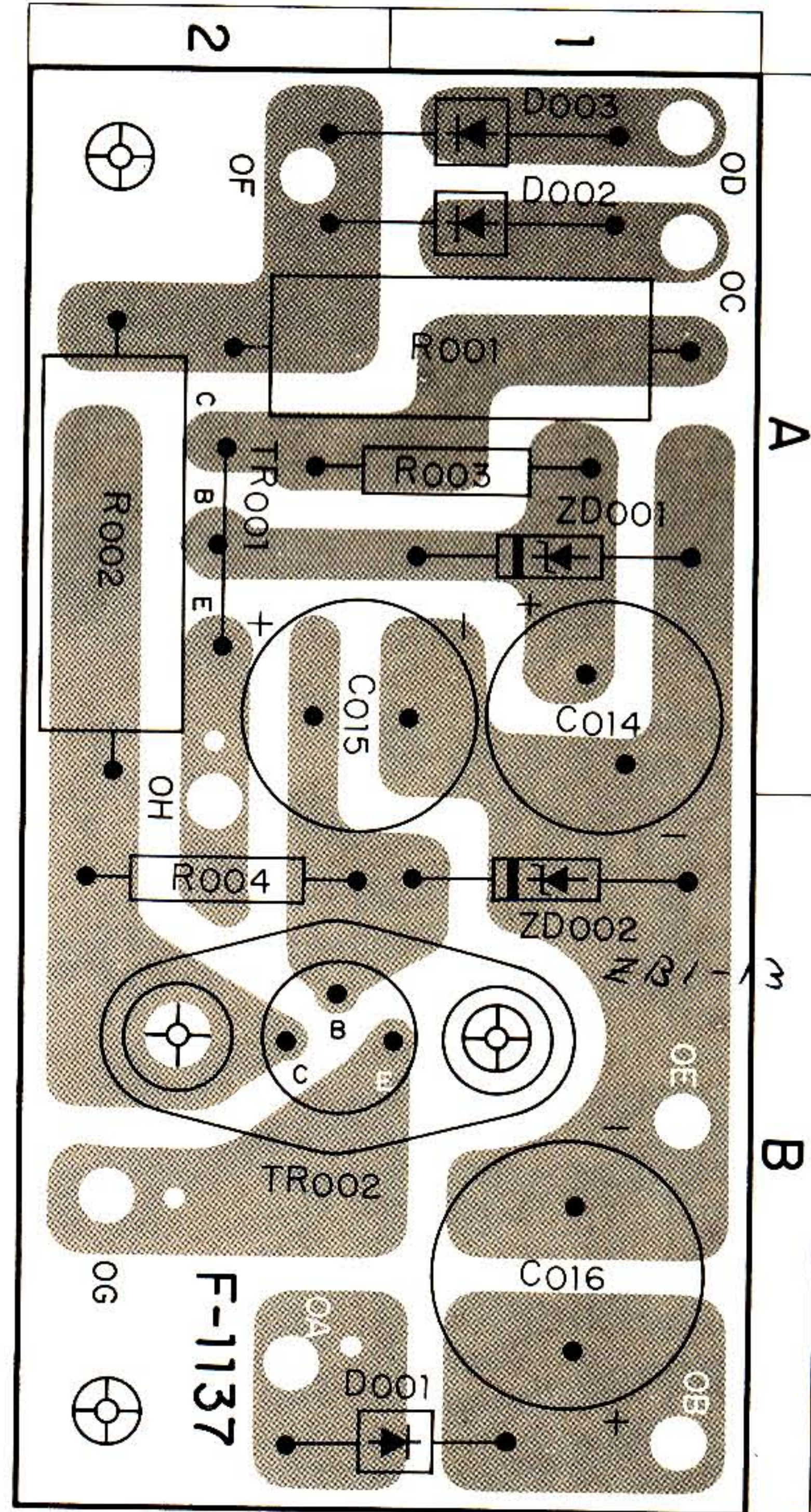

X	Y			Z
R001	68 Ω	3 W	$\pm 10\%$ WW Fixed	
R002	180 Ω	3 W	$\pm 10\%$ WW Fixed	
R003	3.9K Ω	$\frac{1}{2}$ W	$\pm 10\%$ Solid Fixed	
R004	1.5K Ω	$\frac{1}{2}$ W	$\pm 10\%$ Solid Fixed	
C014	220 μ F	25 VDCW.	ELECT.	
C015	330 μ F	16 VDCW.	ELECT.	
C016	1000 μ F	10 VDCW.	ELECT.	
TR001	2SD72 TR		030812-1	
TR002	2SD205 TR		030813-0~2	
D001	SW-05-02 D		031017	
D002	SW-05-02 D		031017	
D003	SW-05-02 D		031017	

PRINTED CIRCUIT SHEETS AND PARTS LIST

F-1038 <AM IF>

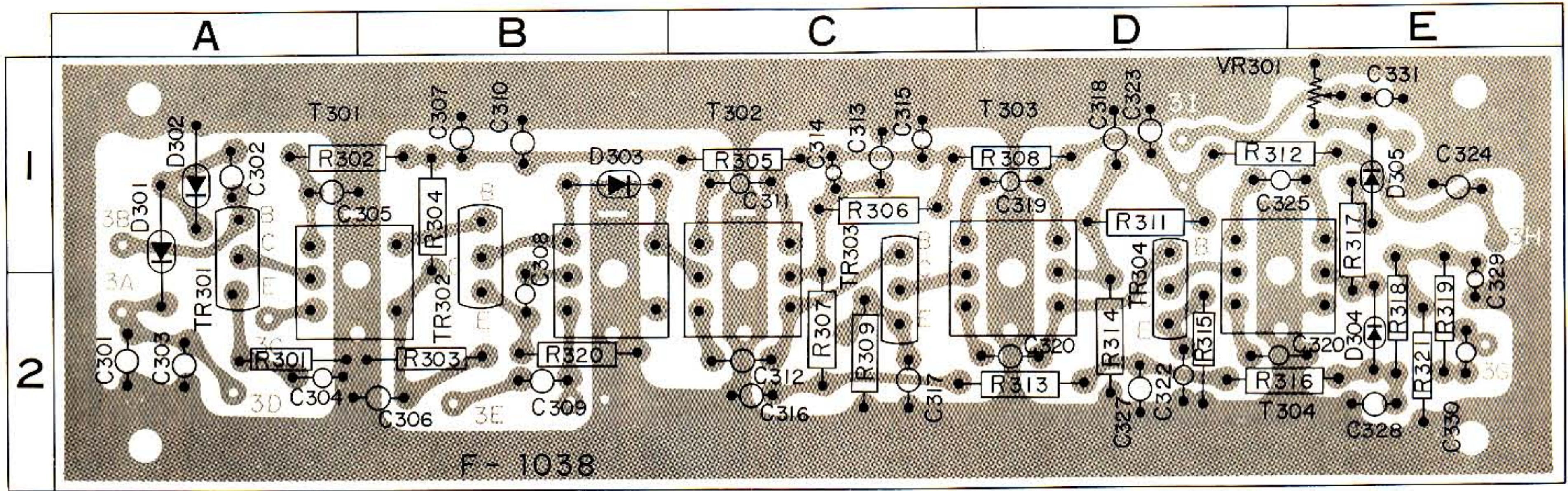

X	Y	Z
R301	1KΩ ¼W ±10% PREC. Fixed	2 A
R302	100Ω ¼W ±10% PREC. Fixed	1 A, B
R303	3.9KΩ ¼W ±10% PREC. Fixed	2 B
R304	33KΩ ¼W ±10% PREC. Fixed	1 B
R305	100Ω ¼W ±10% PREC. Fixed	1 C
R306	68KΩ ¼W ±10% PREC. Fixed	1 C
R307	22Ω ¼W ±10% PREC. Fixed	2 C
R308	22Ω ¼W ±10% PREC. Fixed	1 D
R309	1KΩ ¼W ±10% PREC. Fixed	2 C
R311	10KΩ ¼W ±10% PREC. Fixed	1 D
R312	22Ω ¼W ±10% PREC. Fixed	1 D, E
R313	100Ω ¼W ±10% PREC. Fixed	2 D
R314	6.8KΩ ¼W ±10% PREC. Fixed	2 D
R315	470Ω ¼W ±10% PREC. Fixed	2 D
R316	8.2KΩ ¼W ±10% PREC. Fixed	2 D, E
R317	1KΩ ¼W ±10% PREC. Fixed	1, 2 E
R318	1KΩ ¼W ±10% PREC. Fixed	2 E
R319	120KΩ ¼W ±10% PREC. Fixed	2 E
R320	1KΩ ¼W ±10% PREC. Fixed	2 B
R321	47KΩ ¼W ±10% PREC. Fixed	2 E
VR301	20KΩ (103019)	1 E
C301	0.04μF 50 VDCW. CER.	2 A
C302	0.04μF 50 VDCW. CER.	1 A
C303	100μF 6 VDCW. ELECT.	2 A
C304	0.02μF 50 VDCW. CER.	2 A
C305	0.04μF 50 VDCW. CER.	1 A
C306	0.04μF 50 VDCW. CER.	2 B
C307	100μF 15 VDCW. ELECT.	1 B
C308	0.01μF 50 VDCW. My.	1 B
C309	430 pF 50 VDCW. Mc.	2 B
C310	0.02μF 50 VDCW. CER.	1 B
C311	500 pF 50 VDCW. Mc.	1 C
C312	500 pF 50 VDCW. Mc.	2 C

X	Y	Z
C313	5μF 15 VDCW. ELECT.	1 C
C314	0.02μF 50 VDCW. CER.	1 C
C315	0.02μF 50 VDCW. CER.	1 C
C316	0.04μF 50 VDCW. CER.	2 C
C317	50μF 6 VDCW. ELECT.	2 C
C318	0.02μF 50 VDCW. CER.	1 D
C319	500 pF 50 VDCW. Mc.	1 D
C320	500 pF 50 VDCW. Mc.	2 D
C322	0.04μF 50 VDCW. CER.	2 D
C323	0.02μF 50 VDCW. CER.	1 D
C324	200μF 15 VDCW. ELECT.	1 E
C325	500 pF 50 VDCW. Mc.	1 D, E
C326	500 pF 50 VDCW. Mc.	2 D, E
C327	0.02μF 50 VDCW. CER.	2 D
C328	0.02μF 50 VDCW. My.	2 E
C329	0.01μF 50 VDCW. My.	2 E
C330	0.04μF 50 VDCW. CER.	2 E
C331	10μF 6 VDCW. ELECT.	1 E
D301	IN60	1 A
D302	IN60	1 A
D303	IN60	1 B
D304	IN60	2 E
D306	IN60	1 E
TR301	2SC460 or 2SC461(C) Si N-P-N	1, 2 A
TR302	2SC460 Si N-P-N	1, 2 B
TR303	2SC460 Si N-P-N	1, 2 C
TR304	2SC460 or 2SC461(C) Si N-P-N	1, 2 D
T301	AMRF (421005)	1, 2 A B
T302	AMOSC (422007)	1, 2 B
T303	AM IFT 455KHz (423019)	1, 2 C
T304	AM IFT 455KHz (423019)	1, 2 C D
T305	AM IFT 455KHz (423018)	1, 2 D E

X: Parts No.
 Y: Parts Name
 Z: Co-ordinates in Printed Circuit Sheets

F-1051 < HIGH-LOW FILTER >

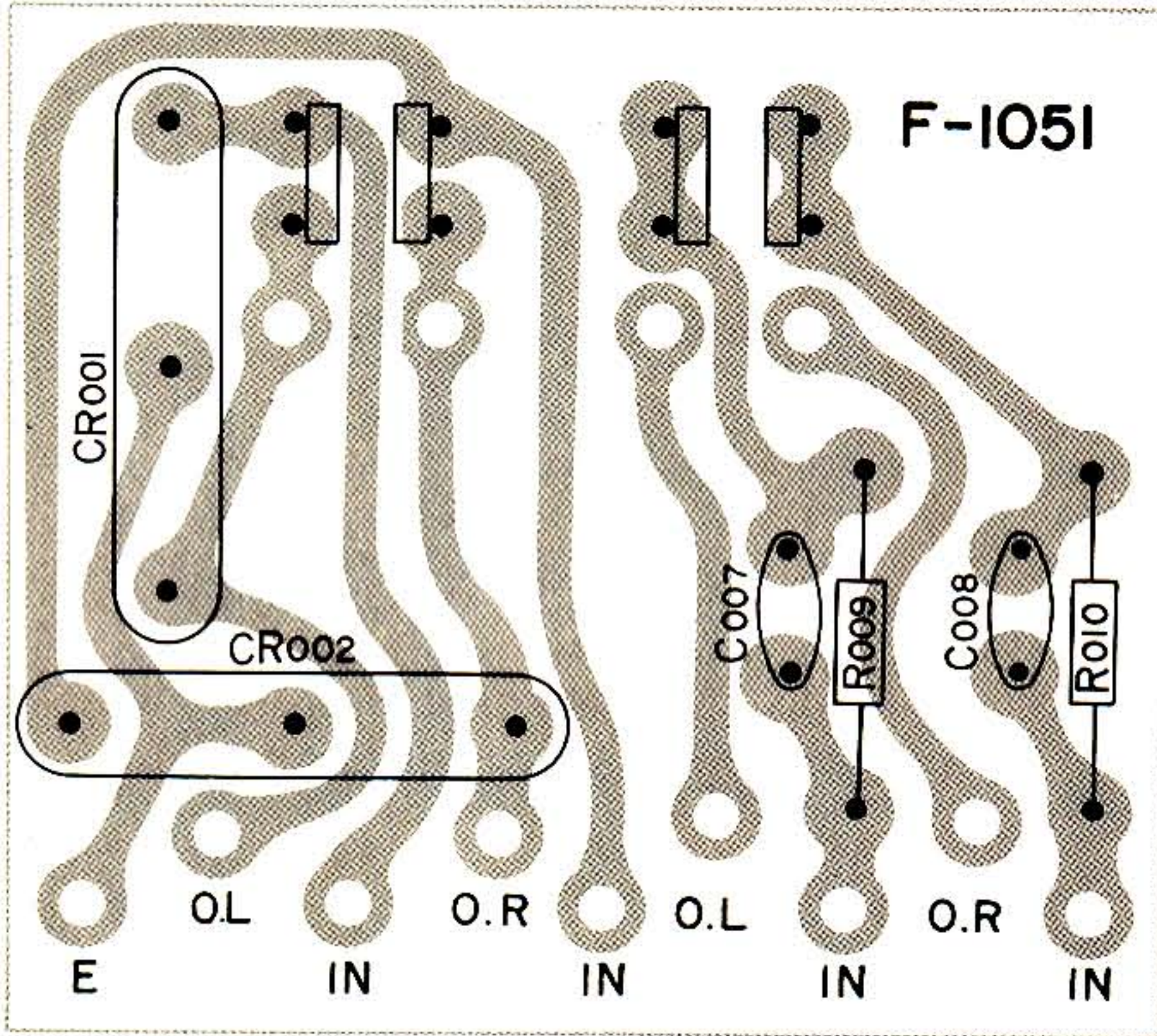

X	Y	Z
R009	470KΩ 1/4W ±10% PREC. Fixed	
R010	470KΩ 1/4W ±10% PREC. Fixed	
C007	0.0068μF 50 VDCW. My.	
C008	0.0068μF 50 VDCW. My.	
CR001	Low Filter CER.	
CR002	Low Filter CER.	

< TAPE MONITOR SW >

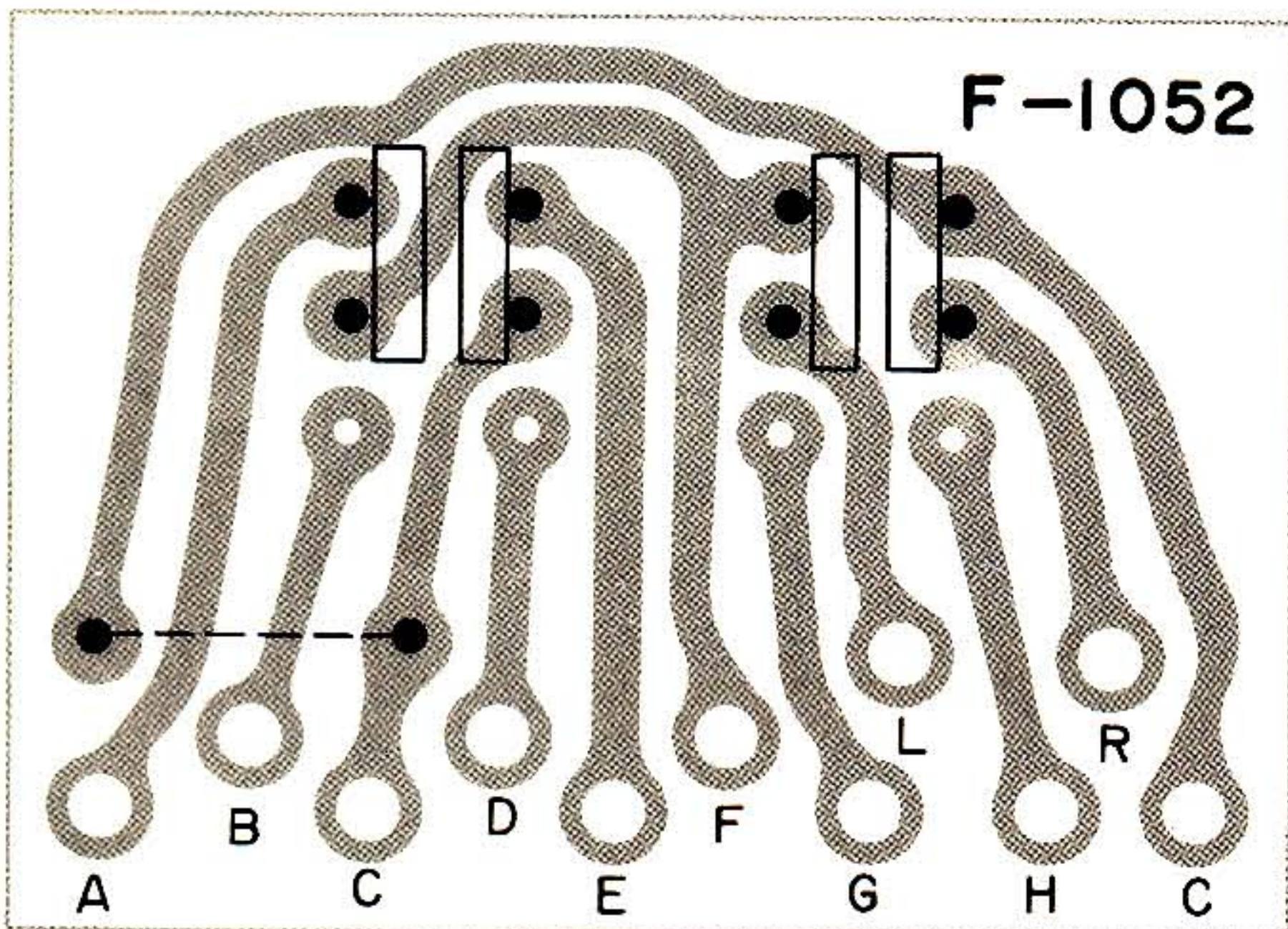

F-1056 < ACCESSORY CIRCUIT >

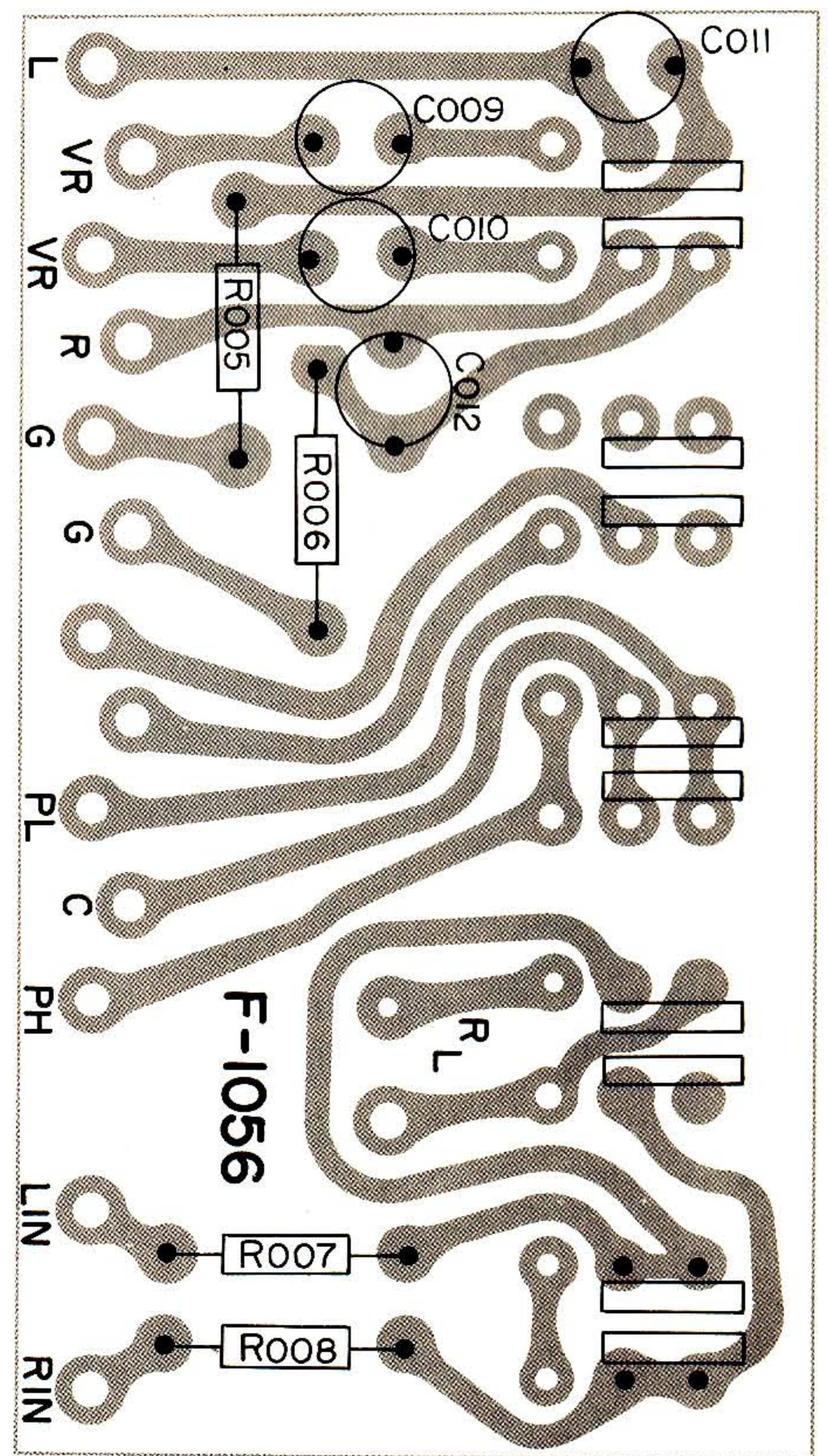

X	Y	Z
R005	33KΩ 1/4W ±10% PREC. Fixed	
R006	33KΩ 1/4W ±10% PREC. Fixed	
R007	8.2KΩ 1/4W ±10% PREC. Fixed	
R008	8.2KΩ 1/4W ±10% PREC. Fixed	
C009	0.022μF 50 VDCW. My.	
C010	0.022μF 50 VDCW. My.	
C011	150 pF 50 VDCW. Mc.	
C012	150 pF 50 VDCW. Mc.	

PARTS LIST

X: Part No.
Y: Parts Name
Z: Drawing No.

F-1011 ◀ FM TUNER ▶

X	Y	Z
C101	100 pF ±20% 50 VDCW. CER.	①
C102	15 pF ±0.5pF 50 VDCW. CER.	②
C106	15 pF ±0.5pF 50 VDCW. CER.	
C112	15 pF ±0.5pF 50 VDCW. CER.	
C103	0.001 μF $\frac{+100}{-0}\%$ 50 VDCW. CER.	③
C105	0.001 μF $\frac{+100}{-0}\%$ 50 VDCW. CER.	
C108	0.001 μF $\frac{+100}{-0}\%$ 50 VDCW. CER.	
C110	0.001 μF $\frac{+100}{-0}\%$ 50 VDCW. CER.	
C111	0.001 μF $\frac{+100}{-0}\%$ 50 VDCW. CER.	
C114	0.001 μF $\frac{+100}{-0}\%$ 50 VDCW. CER.	
C116	0.001 μF $\frac{+100}{-0}\%$ 50 VDCW. CER.	
C118	0.001 μF $\frac{+100}{-0}\%$ 50 VDCW. CER.	
C121	0.001 μF $\frac{+100}{-0}\%$ 50 VDCW. CER.	
C124	0.001 μF $\frac{+100}{-0}\%$ 50 VDCW. CER.	
C104	0.002 μF $\frac{+100}{-0}\%$ 50 VDCW. CER.	④
C109	0.002 μF $\frac{+100}{-0}\%$ 50 VDCW. CER.	
C126	0.002 μF $\frac{+100}{-0}\%$ 50 VDCW. CER.	
C107	6 pF ±0.25pF 50 VDCW. CER.	⑤
C113	5 pF ±0.5pF 50 VDCW. CER.	⑥
C115	20 pF ±10% 50 VDCW. CER.	⑦
C117	120 pF ±5% 50 VDCW. CER.	⑧
C119	160 pF ±5% 50 VDCW. CER.	⑨
C120	220 pF ±5% 50 VDCW. CER.	⑩
C122	5 pF ±10% 50 VDCW. CER.	⑪
C123	2 pF ±10% 50 VDCW. CER.	⑫
C125	30 pF ±10% 50 VDCW. CER.	⑬
C127	15 pF ±10% 50 VDCW. CER.	⑭
R101	100KΩ $\frac{1}{4}$ W ±10% PREC. Fixed	⑮
R102	1MΩ $\frac{1}{4}$ W ±10% PREC. Fixed	⑯

X	Y	Z
R103	120Ω $\frac{1}{4}$ W ±10% PREC. Fixed	⑰
R113	120Ω $\frac{1}{4}$ W ±10% PREC. Fixed	
R114	120Ω $\frac{1}{4}$ W ±10% PREC. Fixed	
R104	1KΩ $\frac{1}{4}$ W ±10% PREC. Fixed	⑱
R112	1KΩ $\frac{1}{4}$ W ±10% PREC. Fixed	
R105	47KΩ $\frac{1}{4}$ W ±10% PREC. Fixed	⑲
R106	680Ω $\frac{1}{4}$ W ±10% PREC. Fixed	⑳
R107	8.2KΩ $\frac{1}{4}$ W ±10% PREC. Fixed	㉑
R108	2.2KΩ $\frac{1}{4}$ W ±10% PREC. Fixed	㉒
R109	1.8KΩ $\frac{1}{4}$ W ±10% PREC. Fixed	㉓
R110	8.2KΩ $\frac{1}{4}$ W ±10% PREC. Fixed	㉔
R111	3.3KΩ $\frac{1}{4}$ W ±10% PREC. Fixed	㉕
R115	2Ω $\frac{1}{4}$ W ±10% PREC. Fixed	㉖
FET101	MPF-102 Junction type	㉗
TR101	SE5050 Si N-P-N	㉘
TR102	SE3001 Si N-P-N	㉙
TR103	SE3001 Si N-P-N	㉚
L101	FM RF Coil	㉛
L102	FM RF Coil	㉜
L103	FM RF Coil	㉝
L105	FM Coil	㉞
L104	FM IF Coil	㉟
L106	FM RF Coil	㊱
TC101	2~8pF Trim	㊲
TC102	2~8pF Trim	
TC103	2~8pF Trim	
TC104	2~8pF Trim	

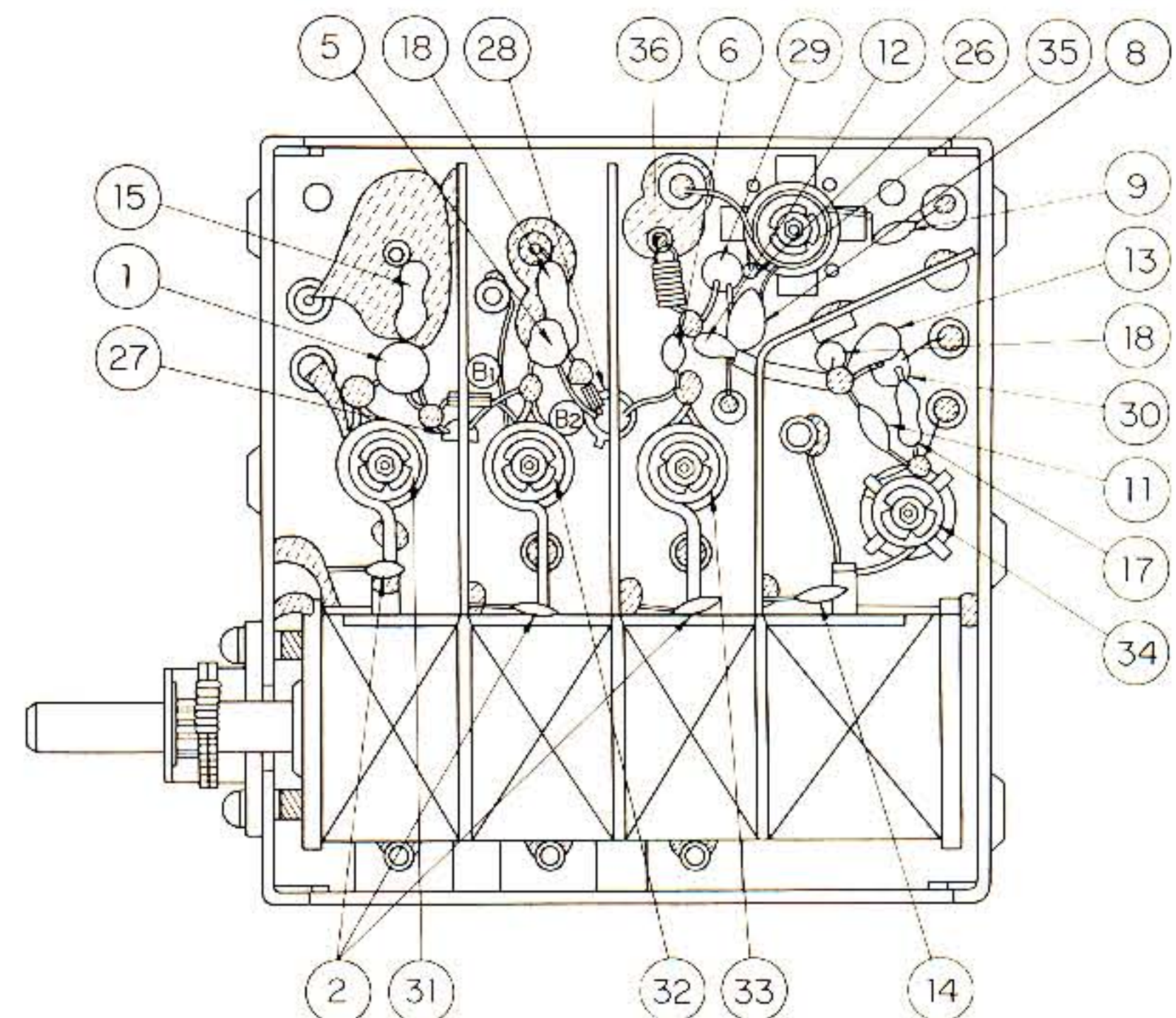
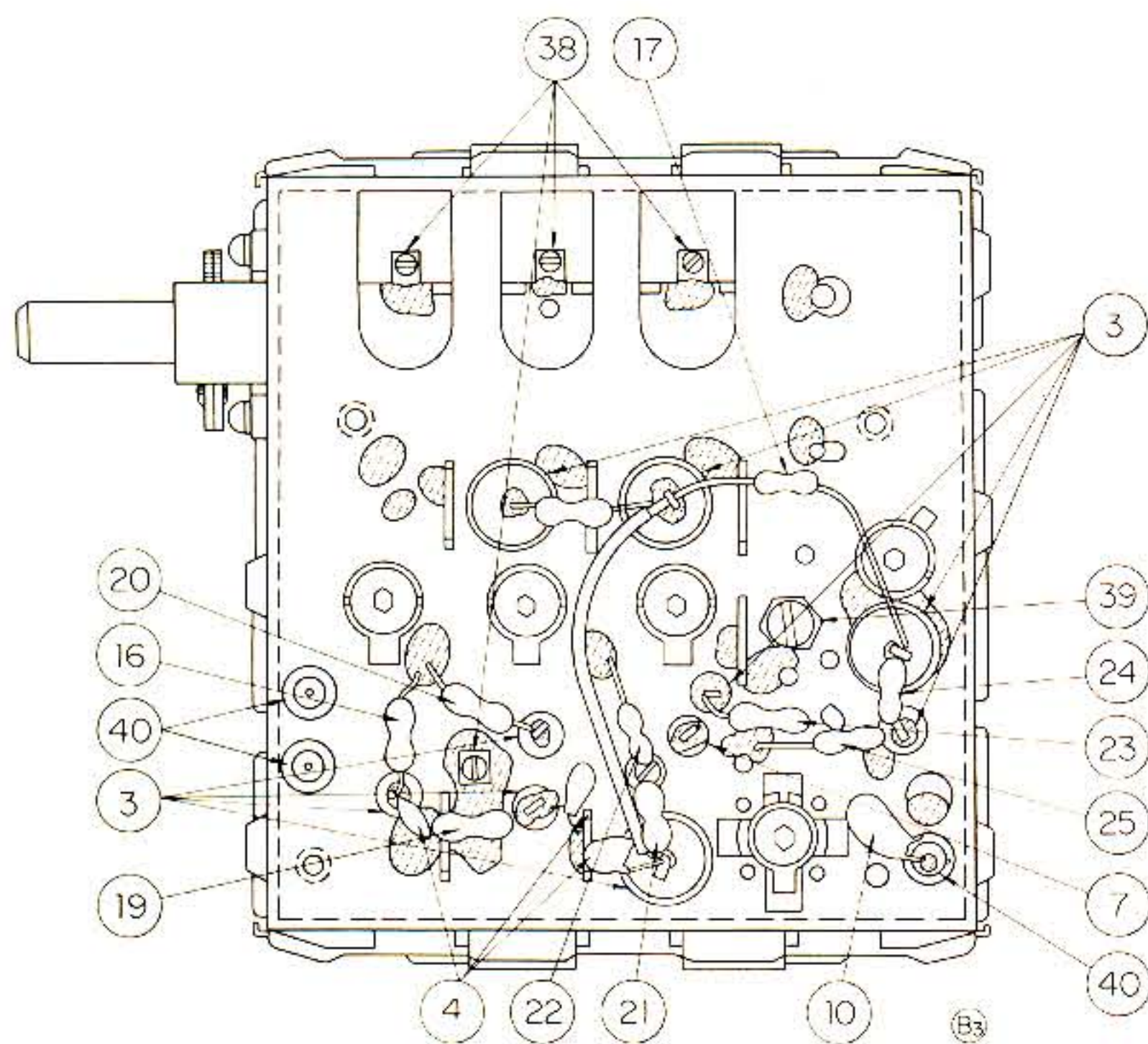

X: Parts No.
Y: Parts Name
Z: Co-ordinates in Printed Circuit Sheets

F-1042 < DIODES STACK >

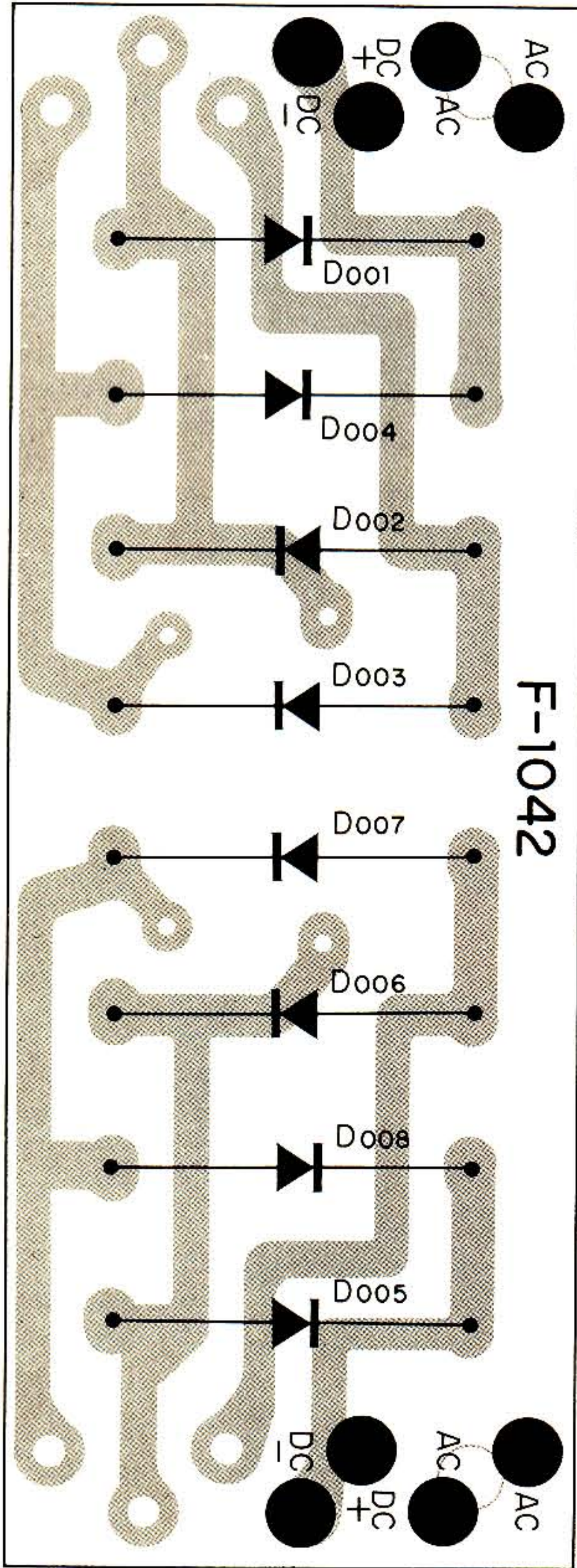

X	Y	Z
D001	SW-1-02 (031055)	
D002	SW-1-02 (031055)	
D003	SW-1-02 (031055)	
D004	SW-1-02 (031055)	
D005	SW-1-02 (031055)	
D006	SW-1-02 (031055)	
D007	SW-1-02 (031055)	
D008	SW-1-02 (031055)	

F-1041 < PROTECTOR >

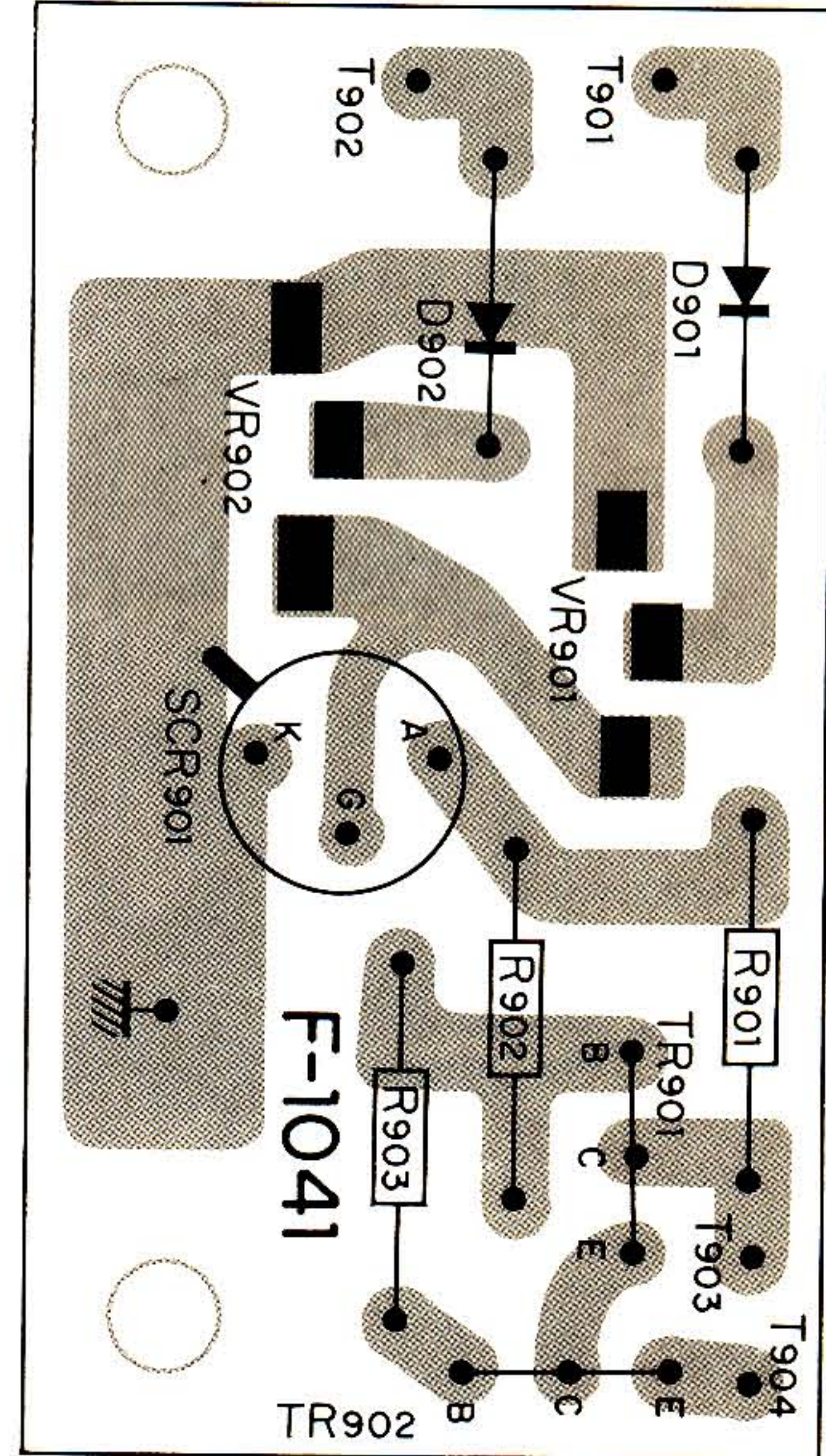

X	Y	Z
R901	2.2Ω ¼W ±10% COMP. Fixed	
R902	10Ω ¼W ±10% COMP. Fixed	
R903	10Ω ¼W ±10% COMP. Fixed	
VR901	2KΩ (B) Semi-Variable	
VR902	2KΩ (B) Semi-Variable	
D901	1N60	
D902	1N60	
SCR901	2SF251	
TR901	2SC458 L(B)	
TR902	2SC458 L(B)	

OTHER PARTS CHART AND PARTS LIST

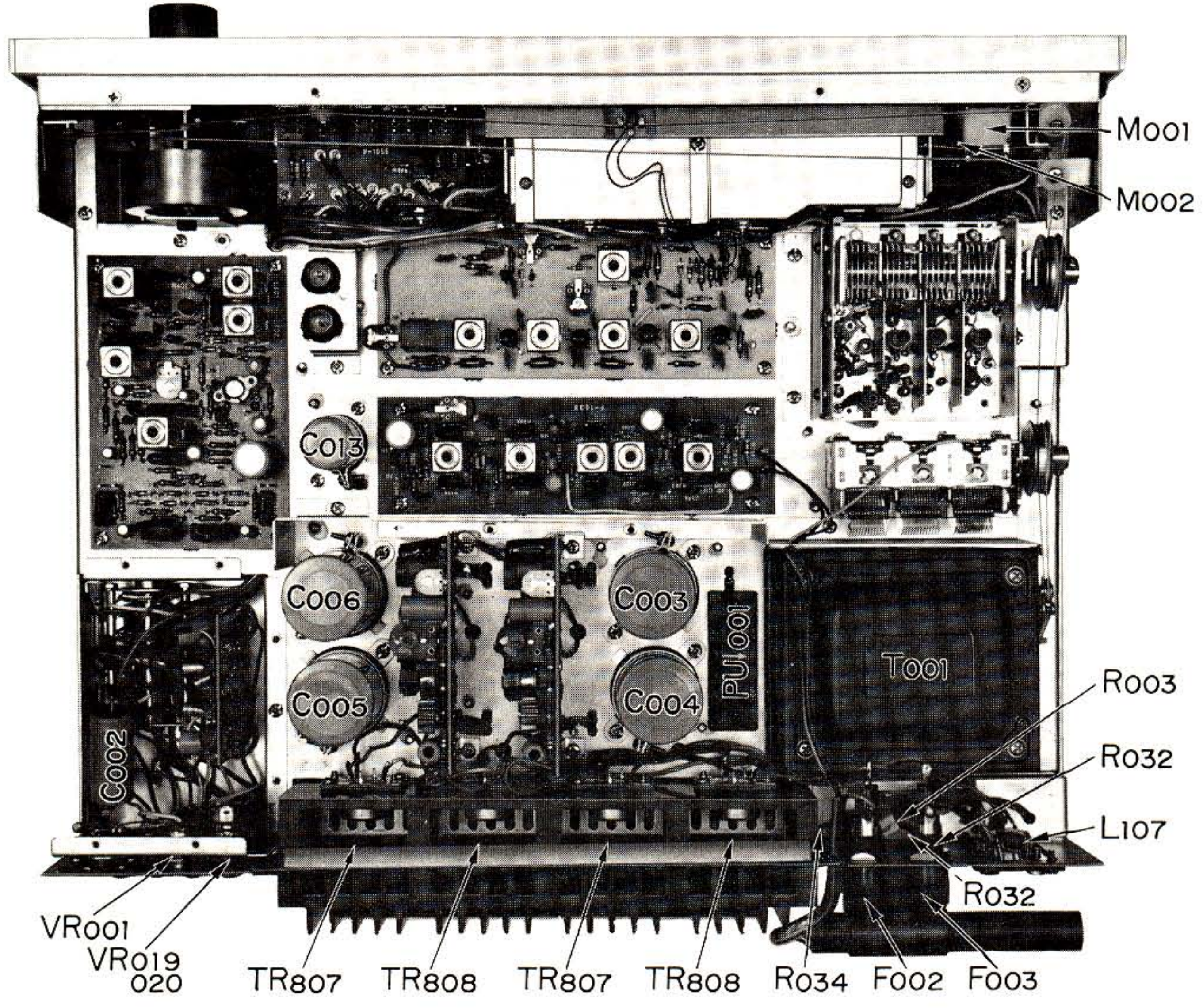
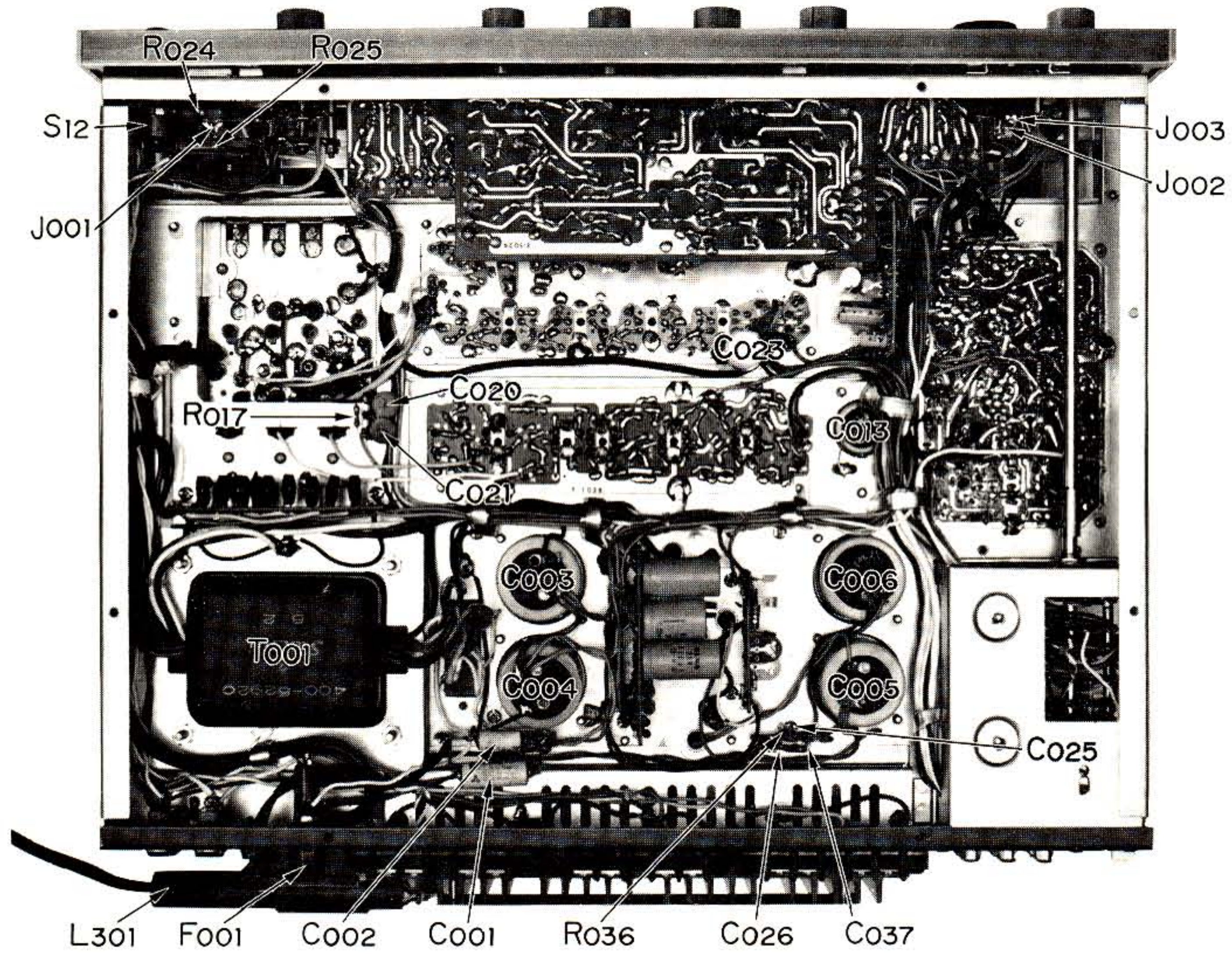

X: Parts No.
Y: Parts Name

X	Y			
R005	33KΩ	¼W	±10%	PREC. Fixed
R006	33KΩ	¼W	±10%	PREC. Fixed
R007	8.2KΩ	¼W	±10%	PREC. Fixed
R008	8.2KΩ	¼W	±10%	PREC. Fixed
R009	470KΩ	¼W	±10%	PREC. Fixed
R010	470KΩ	¼W	±10%	PREC. Fixed
R011	150KΩ	¼W	±10%	PREC. Fixed
R012	150KΩ	¼W	±10%	PREC. Fixed
R013	12KΩ	¼W	±10%	PREC. Fixed
R014	12KΩ	¼W	±10%	PREC. Fixed
R015	22KΩ	¼W	±10%	PREC. Fixed
R016	1.5KΩ	¼W	±10%	PREC. Fixed
R017	22KΩ	¼W	±10%	PREC. Fixed
R018	22KΩ	¼W	±10%	PREC. Fixed
R019	22KΩ	¼W	±10%	PREC. Fixed
R020	22KΩ	¼W	±10%	PREC. Fixed
R022	68KΩ	¼W	±10%	PREC. Fixed
R023	68KΩ	¼W	±10%	PREC. Fixed
R024	680Ω	1 W	±10%	Carbon Fixed
R025	680Ω	1 W	±10%	Carbon Fixed
R026	18Ω	¼W	±10%	PREC. Fixed
R027	100KΩ	¼W	±10%	PREC. Fixed
R028	100KΩ	¼W	±10%	PREC. Fixed
R029	470KΩ	¼W	±10%	PREC. Fixed
R030	470KΩ	¼W	±10%	PREC. Fixed
R031	680Ω	¼W	±10%	PREC. Fixed
R032	56Ω	¼W	±10%	PREC. Fixed
R033	0.3Ω	5 W	±10%	WW
R034	0.3Ω	5 W	±10%	WW
R035	1KΩ	¼W	±10%	PREC. Fixed
R036	6.8KΩ	¼W	±10%	PREC. Fixed
R037	6.8KΩ	¼W	±10%	PREC. Fixed
R038	180KΩ	¼W	±10%	PREC. Fixed
R039	100KΩ	¼W	±10%	PREC. Fixed
R040	15KΩ	¼W	±10%	PREC. Fixed
R041	33KΩ	¼W	±10%	PREC. Fixed
R042	33KΩ	¼W	±10%	PREC. Fixed
C001	0.033μF	±20%	600 VDCW.	Oil
C002	0.0047μF	±20%	600 VDCW.	Oil
C003	2200μF	+100% -0%	80 VDCW.	ELECT.
C004	2200μF	+100% -0%	80 VDCW.	ELECT.
C005	2200μF	+100% -0%	80 VDCW.	ELECT.
C006	2200μF	+100% -0%	80 VDCW.	ELECT.
C007	0.0047μF	±10%	50 VDCW.	My.
C008	0.0047μF	±10%	50 VDCW.	My.
C009	150 pF	±10%	50 VDCW.	Mc.
C010	150 pF	±10%	50 VDCW.	Mc.
C011	0.02μF	±10%	50 VDCW.	My.
C012	0.02μF	±10%	50 VDCW.	My.
C013	1000μF	+100% -0%	35 VDCW.	ELECT. (020528)
C019	0.002μF	±10%	50 VDCW.	ELECT.
C020	0.04μF	+100% -0%	50 VDCW.	CER.
C021	0.04μF	+100% -0%	50 VDCW.	CER.
C022	470μF	+100% -0%	25 VDCW.	ELECT.
C023	470μF	+100% -0%	15 VDCW.	ELECT.

X	Y			
C024	1μF	+100% -0%	50 WV	ELECT.
C025	70 pF	+100% -0%	50 WV	CER.
C026	70 pF	+100% -0%	50 WV	CER.
C027	3.3μF	±100%	25 WV	ELECT.
C028	3.3μF	±100%	25 WV	ELECT.
C029	3.3μF	±100%	25 WV	ELECT.
TR807,808	2SD118	Si	N-P-N	
TR807,808	2SD118	Si	N-P-N	
D004	IN60	Ge	Diode	
D005	IN60	Ge	Diode	
PL001	Protector indicator	25V	90mA	(040007)
PL002	Stereo Indicator Lamp	8V	150mA	(040005)
PL003	Power Indicator Lamp	6.3V	250mA	(040009)
PL004	Power Indicator Lamp	6.3V	250mA	(040009)
PL005	Tape Indicator Lamp	6.3V	250mA	(040009)
PL006	Phono Indicator Lamp	6.3V	250mA	(040009)
PL007	Dial Indicator Lamp	6.3V	250mA	(040009)
PL008	Dial Indicator Lamp	6.3V	250mA	(040009)
PL009	Dial Indicator Lamp	6.3V	250mA	(040009)
PL010	Dial Indicator Lamp	6.3V	250mA	(040009)
PL011	Dial Indicator Lamp	6.3V	250mA	(040009)
PL012	Aux Indicator Lamp	6.3V	250mA	(040009)
PL013	Needle Indicator Lamp	5V	60mA	(040010)
CO001	AC Outlet	(245002)		
CO002	AC Outlet	(245002)		
PU001	Line Voltage Controller	(241008, 241009)		
M001	Tune Meter	100μA	(090012)	
M002	Signal Meter	100μA	(090011)	
L001	AM Ferrite Bar Antenna	240μH	(420014)	
T001	Power Transformer	(400025)		
F001	Power Fuse	5A	(043006)	
F002	Quick Acting Fuse	5A	(043014)	
F003	Quick Acting Fuse	5A	(043014)	
S(1~10)	Selector	(110504)		
S1a	Muting			
S2a	FM Stereo Only			
S3(a~b)	Tape Monitor A	}	(113007)	
S4(a~b)	Tape Monitor B			
S5(a~b)	Reverse			
S6(a~b)	Mono			
S7(a~b)	Loudness			
S8(a~b)	HIGH Filter	}	(113007)	
S9(a~b)	Low Filter			
S10	FM Attenuator	(111004)		
S11	Damping Switch	(111009)		
S2a~b	Speaker Selector Switch	(110208)		
S12	Power Switch	(113009)		
J001	Head Phone Jack	(243007)		
J002	Tape Recording Jack B	(243006)		
J003	Tape Monitor Jack B	(243006)		
VR001	5KΩ(B) Separation Adjust	(100501)		
VR019	} 50KΩ(B) Level Adjust	(101501)		
VR020				

* All rights reserve specifications subject to change without notice.



Sansui[®]



SANSUI ELECTRIC COMPANY LIMITED



Head Office; 14-1, 2-chome, Izumi, Suginami-ku, Tokyo, Japan. TEL. 323-1111

Printed in Japan (19070M)